

# Panasonic®

## Operating Instructions

DVD Recorder

Model No. **DMR-EH60**



Getting started

Recording

Playing back

Editing

Transferring  
(Dubbing)

Convenient  
functions

Reference

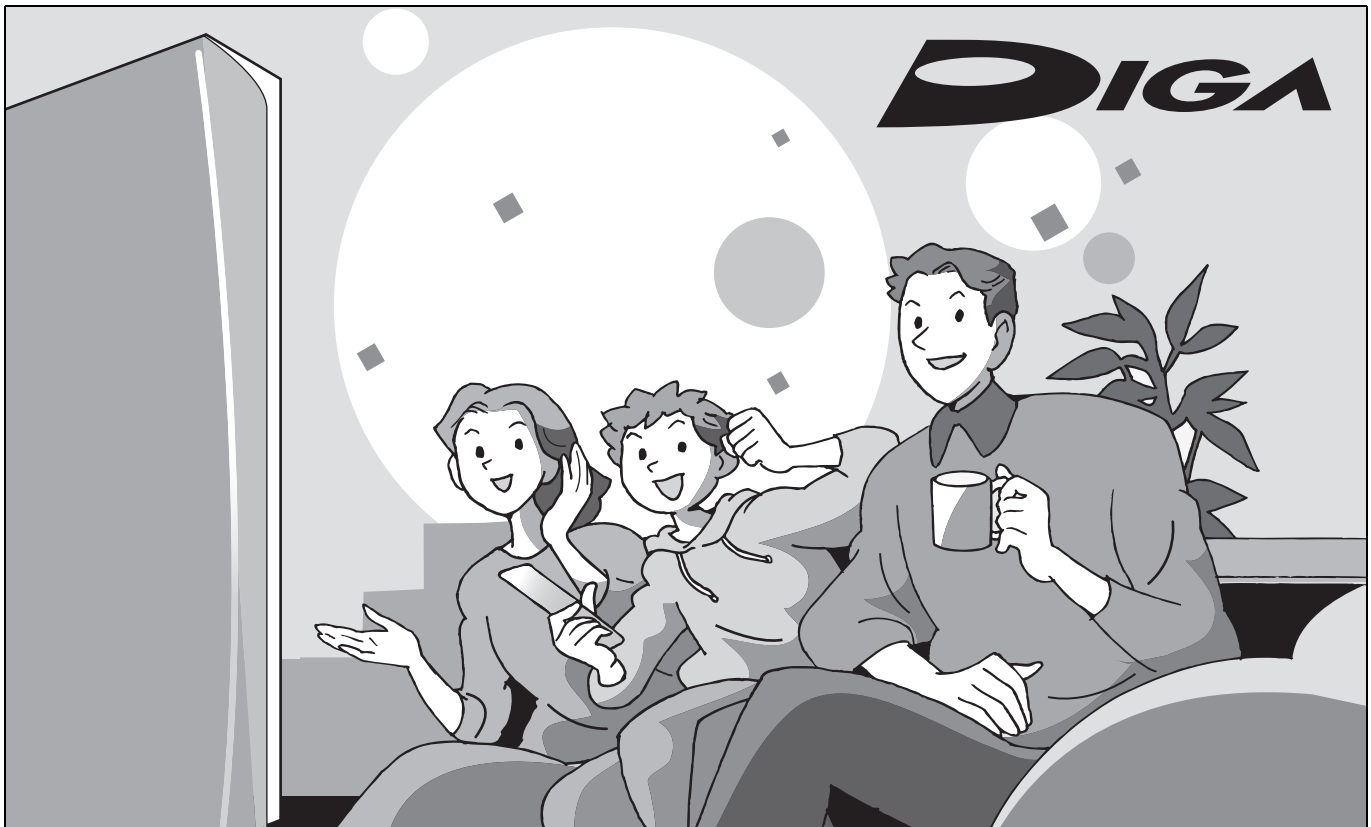

### Dear customer

Thank you for purchasing this product. For optimum performance and safety, please read these instructions carefully.

Before connecting, operating or adjusting this product, please read the instructions completely.

Please keep this manual for future reference.

#### Region number supported by this unit

Region numbers are allocated to DVD players and DVD-Video according to where they are sold.

- The region number of this unit is "1".
- The unit will play DVDs marked with labels containing "1" or "ALL".

Example:



If you have any questions contact

**1-800-561-5505**

The warranty can be found on page 70.

**CAUTION!**

THIS PRODUCT UTILIZES A LASER.  
 USE OF CONTROLS OR ADJUSTMENTS OR PERFORMANCE OF PROCEDURES OTHER THAN THOSE SPECIFIED HEREIN MAY RESULT IN HAZARDOUS RADIATION EXPOSURE. DO NOT OPEN COVERS AND DO NOT REPAIR YOURSELF. REFER SERVICING TO QUALIFIED PERSONNEL.

**WARNING:**

TO REDUCE THE RISK OF FIRE, ELECTRIC SHOCK OR PRODUCT DAMAGE, DO NOT EXPOSE THIS APPARATUS TO RAIN, MOISTURE, DRIPPING OR SPLASHING AND THAT NO OBJECTS FILLED WITH LIQUIDS, SUCH AS VASES, SHALL BE PLACED ON THE APPARATUS.

**CAUTION!**

DO NOT INSTALL OR PLACE THIS UNIT IN A BOOKCASE, BUILT-IN CABINET OR IN ANOTHER CONFINED SPACE. ENSURE THE UNIT IS WELL VENTILATED. TO PREVENT RISK OF ELECTRIC SHOCK OR FIRE HAZARD DUE TO OVERHEATING, ENSURE THAT CURTAINS AND ANY OTHER MATERIALS DO NOT OBSTRUCT THE VENTILATION VENTS.

The socket outlet shall be installed near the equipment and easily accessible or the mains plug or an appliance coupler shall remain readily operable.

-If you see this symbol-

**Information on Disposal in other Countries outside the European Union**



This symbol is only valid in the European Union. If you wish to discard this product, please contact your local authorities or dealer and ask for the correct method of disposal.

DANGER	- VISIBLE AND INVISIBLE LASER RADIATION WHEN OPEN. AVOID DIRECT EXPOSURE TO BEAM. (FDA 21 CFR)
CAUTION	- VISIBLE AND INVISIBLE LASER RADIATION WHEN OPEN. AVOID EXPOSURE TO BEAM. (IEC60825-1)
ATTENTION	- RAYONNEMENT LASER VISIBLE ET INVISIBLE EN CAS D'OUVERTURE. EXPOSITION DANGEREUSE AU FAISCEAU.
ADVARSEL	- SYNLIG OG USYNLIG LASERSTRÅLING VED ÅBNING. UNDGÅ UDSÆTTELSE FOR STRÅLING.
VARO!	- AVATTAMASSA OLET ALTIINNA NÄKYVÄÄ JA NÄKYMÄTÖN LASERISÄTELYLLÄ. ÄLÄ KATSO SÄTEESEEN.
VARNING	- SYNLIG OCH OSYNLIG LASERSTRÅLNING NÄR DENNA DEL ÄR ÖPPNAD. BETRÄKTA EJ STRÅLEN.
ADVARSEL	- SYNLIG OG USYNLIG LASERSTRÅLING NÄR DEKSEL ÅPNES. UNNGÅ EKSPONERING FOR STRÅLEN.
VORSICHT	- SICHTBARE UND UNSICHTBARE LASERSTRÄHLUNG, WENN ABDECKUNG GEÖFFNET. NICHT DEN STRAHL AUSSETZEN.
注意	- 打开时有可见及不可见激光辐射。避免激光束照射。
注意	- ここを開くと可視及び不可視のレーザー光が出ます。ビームを直接見たり、触れたりしないでください。 ROLS0233

(Inside of product)

**CAUTION**

**RISK OF ELECTRIC SHOCK  
DO NOT OPEN**

CAUTION: TO REDUCE THE RISK OF ELECTRIC SHOCK, DO NOT REMOVE SCREWS. NO USER-SERVICEABLE PARTS INSIDE. REFER SERVICING TO QUALIFIED SERVICE PERSONNEL.

The lightning flash with arrowhead symbol, within an equilateral triangle, is intended to alert the user to the presence of uninsulated “dangerous voltage” within the product’s enclosure that may be of sufficient magnitude to constitute a risk of electric shock to persons.

The exclamation point within an equilateral triangle is intended to alert the user to the presence of important operating and maintenance (servicing) instructions in the literature accompanying the appliance.

# IMPORTANT SAFETY INSTRUCTIONS

Read these operating instructions carefully before using the unit. Follow the safety instructions on the unit and the applicable safety instructions listed below. Keep these operating instructions handy for future reference.

- |   |   |
|---|---|
| <ol style="list-style-type: none"> <li>1) Read these instructions.</li> <li>2) Keep these instructions.</li> <li>3) Heed all warnings.</li> <li>4) Follow all instructions.</li> <li>5) Do not use this apparatus near water.</li> <li>6) Clean only with dry cloth.</li> <li>7) Do not block any ventilation openings. Install in accordance with the manufacturer’s instructions.</li> <li>8) Do not install near any heat sources such as radiators, heat registers, stoves, or other apparatus (including amplifiers) that produce heat.</li> <li>9) Do not defeat the safety purpose of the polarized or grounding-type plug. A polarized plug has two blades with one wider than the other. A grounding-type plug has two blades and a third grounding prong. The wide blade or the third prong are provided for your safety. If the provided plug does not fit into your outlet, consult an electrician for replacement of the obsolete outlet.</li> </ol> | <ol style="list-style-type: none"> <li>10) Protect the power cord from being walked on or pinched particularly at plugs, convenience receptacles, and the point where they exit from the apparatus.</li> <li>11) Only use attachments/accessories specified by the manufacturer.</li> <li>12) Use only with the cart, stand, tripod, bracket, or table specified by the manufacturer, or sold with the apparatus. When a cart is used, use caution when moving the cart/apparatus combination to avoid injury from tip-over.</li> <li>13) Unplug this apparatus during lightning storms or when unused for long periods of time.</li> <li>14) Refer all servicing to qualified service personnel. Servicing is required when the apparatus has been damaged in any way, such as power-supply cord or plug is damaged, liquid has been spilled or objects have fallen into the apparatus, the apparatus has been exposed to rain or moisture, does not operate normally, or has been dropped.</li> </ol> |
|---|---|



## Getting started

<b>IMPORTANT SAFETY INSTRUCTIONS</b> .....	2
<b>Useful features</b> .....	3
<b>HDD (Hard disk drive) handling care</b> .....	4
<b>Disc and card handling</b> .....	5
<b>Unit care</b> .....	5
<b>Inserting/Removing the SD card</b> .....	5
<b>Using DVD-R, DVD-RW and +R on this unit</b> .....	6
<b>Accessories</b> .....	7
<b>The remote control</b> .....	7
<b>HDD, disc and card information</b> .....	8
<b>Control reference guide</b> .....	10
<b>STEP 1 Connection</b> .....	12
<b>STEP 2 Setting up the TV Guide On Screen™ system</b> .....	16
<b>STEP 3 Set up to match your television and the unit's remote control/Power saving function</b> .....	18

## Recording

<b>Recording television programs</b> .....	20
Selecting audio to record .....	22
Recording for High-Speed Dubbing .....	22
Flexible Recording .....	22
Playing while you are recording .....	23
<b>Scheduled recording</b> .....	24
Using the TV Guide On Screen™ system to make scheduled recordings .....	24
Manually programming scheduled recordings .....	25
Using VCR Plus+ system to make scheduled recordings .....	26
Check, change or delete a program .....	27
<b>Utilizing the TV Guide On Screen™ system</b> .....	28

## Playing back

<b>Playing recorded video contents/</b>	
<b>Playing play-only discs</b> .....	30
Operations during play .....	31
Simple editing operations during play .....	32
Changing audio during play .....	32
<b>Using menus to play MP3</b> .....	33
<b>Playing still pictures (JPEG/TIFF)</b> .....	34
Useful functions during still picture play .....	35
<b>Using on-screen menus/FUNCTIONS window and Status message</b> .....	36
Using on-screen menus .....	36
FUNCTIONS window .....	37
Status messages .....	37

## Editing

<b>Editing titles/chapters</b> .....	38
Editing titles/chapters and playing chapters .....	38
Title operations .....	39
Chapter operations .....	39

## Useful features

This DVD Recorder records high quality images to rapid random access capable HDD (Hard disk drive) or DVD-RAM. This has resulted in many new features that outperform older tape formats. The following information summarizes a few of these features.

### Instant recording

You no longer need to search for empty disc space. By pressing the recording button, the unit finds available recording space and begins recording right away. There is no need to worry about overwriting already recorded content.

#### 1 Sec. Quick Start for Recording & EPG Display

From the power on, recording starts in about 1 second\* after the REC button is pressed. If the TV GUIDE button is pressed while the unit is off, the Electronic Program Guide (EPG) starts displaying in less than 1 second, with the full EPG displaying in about 1.5 seconds.

\*Only when recording to the HDD or DVD-RAM

### HDD recording

You can keep on recording your favorite programs to an internal HDD that is able to record up to 355 hours when using EP (8H) mode. You can also high speed transfer (dub) your favorite programs to DVD-RAM, DVD-R, DVD-RW (DVD-Video format) or +R and create a backup disc.

### SD card slot, DV input terminal

- The SD card slot of this unit lets you play digital camera photographs and transfer (dub) them from a card to DVD-RAM for easy storage without using a computer.
- The DV automatic recording function of this unit lets you easily transfer (dub) a video to the HDD by connecting only a single DV cable.

## Editing (continued)

<b>Creating, editing and playing playlists</b> .....	40
Creating playlists .....	40
Editing and playing playlists/chapters .....	41
Playlist operations .....	41
Chapter operations .....	41
<b>Editing still pictures</b> .....	42
Picture and folder operation .....	42

## Transferring (Dubbing)

<b>Transferring (dubbing) titles or playlists</b> .....	43
One Touch Transfer (dubbing) .....	44
Transferring (dubbing) using the transferring (dubbing) list .....	44
Transferring (dubbing) a finalized DVD-R, DVD-RW (DVD-Video format) and +R .....	46
<b>Recording from a video cassette recorder</b> .....	47
Manual recording .....	47
DV automatic recording (DV AUTO RECORDING) .....	47
<b>Transferring (dubbing) still pictures</b> .....	48
Transferring (dubbing) using the transferring (dubbing) list .....	48
Transferring (dubbing) all the still pictures on a card—COPY ALL PICTURES .....	49

## Convenient functions

<b>HDD, disc and card management</b> .....	50
Common procedures .....	50
Setting the protection .....	50
Providing a name for a disc .....	50
Erasing all titles and playlists—Erase All Titles .....	51
Erasing all the contents of a disc or card—Format .....	51
Enabling discs to be played on other equipment .....	52
<b>Entering text</b> .....	53
<b>Changing the unit's settings</b> .....	54
Common procedures .....	54
Summary of settings .....	54
<b>Channel/Clock settings when TV Guide On Screen™ system is not used</b> .....	57
Auto channel/clock settings .....	57
Channel captions .....	58

## Reference

<b>Messages</b> .....	59
<b>Frequently asked questions</b> .....	60
<b>Troubleshooting guide</b> .....	62
<b>Specifications</b> .....	67
<b>Glossary</b> .....	68
<b>Product Service</b> .....	69
<b>Limited Warranty</b> .....	70
<b>Index</b> .....	Backcover

### TV Guide On Screen™ system

The TV Guide On Screen™ system provides a handy electronic program guide (EPG) for checking what's on. Setting up to record a broadcast is easy too. Simply select the desired program from the displayed list. You can also search for desired programs alphabetically or by displaying only the programs in a certain category.

- This service may not be available in some areas.

### Instant play

There is no need to rewind or search forward. Direct Navigator guides you to the beginning of the recorded video immediately.

### Chasing playback

There is no need to wait until recording is complete. Without stopping recording, you can play the video currently being recorded from its beginning.

### Simultaneous Recording and Playback

While recording, you can play another video program that was recorded previously.

### Time Slip

During play, and also while recording, you can jump to the scene you wish to view by specifying the skip time.

# HDD (Hard disk drive) handling care

The HDD is a high precision recording instrument and because of its long recording capability and high speed operation it is a very special device that is easily susceptible to damage.

As a basic rule, save important content to a disc as backup.

## ■ The HDD is a device that is not built to withstand vibration/shock or dust

Depending on the setup environment and handling of the HDD some content may become damaged and play and recording may no longer be possible. Especially during operation, do not subject the unit to any vibration, shock, or remove the AC power plug from the household AC outlet. In the event of a power failure during recording or play, the content may be damaged.

## ■ The HDD is a temporary storage device

The HDD is not an everlasting storage device for recorded content. Use the HDD as a temporary storage place for one-off viewing, editing, or saving recorded content to a disc.

## ■ Immediately save (backup) all content as soon as you feel there may be a problem with the HDD

If there is an irregularity within the HDD, repetitive strange sounds or problems with picture (block noise, etc.) may result. Using the HDD in this condition may worsen the problem and in the worst case the HDD may no longer become usable. As soon as you notice this type of problem, transfer (dub) all content to disc and request service. Recorded content (data) on an HDD that has become unusable is unrecoverable.

- When the HDD has been automatically placed in the SLEEP mode (➡ below), or the unit is turned on or off, there may be an unexpected sound. This does not indicate a problem with this unit.

### ■ Setup precautions

- Do not place in an enclosed area where the rear cooling fan and the cooling vents on the side are covered up.
- Place the unit on a surface that is flat and not subject to vibration or impact.
- Do not place on anything that generates heat like a video cassette recorder, etc.
- Do not place in an area often subject to temperature changes.
- Place in an area where condensation does not occur. Condensation is a phenomenon where moisture forms on a cold surface when there is an extreme change in temperature. Condensation may cause internal damage to the unit.



### ● Conditions where condensation may occur

- When there is an extreme change in temperature (moving from a very hot location to a very cold location, or vice versa, or when subjected to an air conditioner or when cooled air directly impacts the unit.) When the HDD (warms during operation) is subjected to cold air, condensation may form on the inside of the HDD and may cause damage to the HDD heads, etc.
- When there is high humidity or a lot of steam in the room.
- During the rainy season.

In the above situation, **without turning the unit on**, let the unit adjust to the room temperature and wait 2–3 hours until condensation is gone.

### ■ Cigarette smoke, etc. causes malfunction or breakdown

The unit may breakdown if cigarette smoke or bug spray/vapor, etc. gets inside the unit.

### ■ While operating

- Do not move the unit or subject to vibration or impact. (The HDD may become damaged.)
  - Do not remove the AC power plug from the household AC outlet, or flip the power breaker switch.
- While the unit is on, the HDD is rotating at high speed. Sound or movement due to rotation is normal.

### ■ When moving the unit

- ① Turn the unit off. (Wait until “BYE” disappears from the display.)
- ② Remove the AC power plug from the household AC outlet.
- ③ Move only after the unit has come to a complete stop (approx. 2 minutes) in order to avoid subjecting to vibration and shock. (Even after turning the unit off, the HDD continues operating for a short time.)

## ■ HDD recording time remaining

This unit records using a VBR (Variable bit rate) data compression system to vary recorded data segments to match video data segments which may cause differences in the displayed amount of time and space remaining for recording.

If the remaining amount of time is insufficient, erase any unwanted titles to create enough space before you start recording. (Erasing a playlist will not increase the amount of time.)

### ■ When “HDD SLP (SLEEP)” appears in the display

The HDD has been automatically placed in the SLEEP mode. (The HDD continues to rotate at high speed while the unit is on. In order to extend the life of the HDD, the HDD will be placed in the SLEEP mode if no operation has been performed for 30 minutes while there is no disc on the disc tray.)

- Press [HDD] to activate.
- While in SLEEP mode play or recording may not begin right away because the HDD takes time to be re-activated.
- When not using the unit, we recommend removing the disc in the tray in order to set the HDD to the SLEEP mode.

### ■ Indemnity concerning recorded content

Panasonic does not accept any responsibility for damages directly or indirectly due to any type of problems that result in loss of recording or edited content (data), and does not guarantee any content if recording or editing does not work properly. Likewise, the above also applies in a case where any type of repair is made to the unit (including any other non-HDD related component).

# Disc and card handling

## How to hold a disc or card

Do not touch the recorded surface or the terminal surface.



## Concerning non-cartridge discs

Be careful about scratches and dirt.

## If there is dirt or condensation on the disc

Wipe with a damp cloth and then wipe dry.



## Handling precautions

- Do not attach labels or stickers to discs. (This may cause disc warping and un-balanced rotation, rendering it unusable.)
- Write on the label side of the disc only with a soft, oil-based felt pen. Do not use ballpoint pens or other hard writing implements.
- Do not use record cleaning sprays, benzene, thinner, static electricity prevention liquids or any other solvent.
- Do not use scratch-protectors or covers.

- Do not expose the terminals of the card to water, garbage or other strange things.
- Do not drop, stack, or impact discs. Do not place objects on them.
- Do not use the following discs:
  - Discs with exposed adhesive from removed stickers or labels (rental discs, etc.).
  - Discs that are badly warped or cracked.
  - Irregularly shaped discs, such as heart shapes.



- Do not place in the following areas:
  - In direct sunlight.
  - In very dusty or humid areas.
  - Near a heater.
  - Locations susceptible to significant difference in temperature (condensation can occur).
  - Where static electricity or electromagnetic waves occur.
- To protect discs from scratches and dirt, return them to their cases or cartridges when you are not using them.

Getting started

**The manufacturer accepts no responsibility and offers no compensation for loss of recorded or edited material due to a problem with the unit or recordable media, and accepts no responsibility and offers no compensation for any subsequent damage caused by such loss.**

### Examples of causes of such losses are

- A disc recorded and edited with this unit is played in a DVD Recorder or computer disc drive manufactured by another company.
- A disc used as described above and then played again in this unit.
- A disc recorded and edited with a DVD Recorder or computer disc drive manufactured by another company is played in this unit.

## Unit care

The precision parts in this unit are readily affected by the environment, especially temperature, humidity, and dust. Cigarette smoke also can cause malfunction or breakdown.

To clean this unit, wipe with a soft, dry cloth.

- Never use alcohol, paint thinner or benzene to clean this unit.
- Before using chemically treated cloth, carefully read the instructions that came with the cloth.

Observe the following points to ensure continued listening and viewing pleasure.

Dust and dirt may adhere to the unit's lens over time, making it impossible to record or play discs.

Use the **DVD lens cleaner** about once every year, depending on frequency of use and the operating environment. Carefully read the lens cleaner's instructions before use.

DVD lens cleaner: RP-CL720PP

**Do not place the unit on amplifiers or equipment that may become hot.**

The heat can damage the unit.



### Note

Do not obstruct the rear panel's internal cooling fan.

**Before moving the unit, ensure the disc tray is empty. Failure to do so will risk severely damaging the disc and the unit.**

## Inserting/Removing the SD card

Only insert or remove the SD card after turning the unit off.

When the card indicator ("SD") on the unit's display is flashing, the card is being read from or written to. Do not turn off the unit or remove the card. Such action may result in malfunction or loss of the card's contents.

### Opening the cover

Press down.

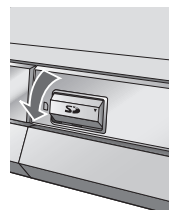

### Inserting the card

Press on the center of the card until it clicks into place.

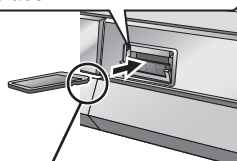

Insert the card label up with the cut-off corner on the right.

(Do not forget to close the cover. → right)

If you are using a miniSD™ card, insert it into the miniSD™ card adaptor that comes with the card. Insert and remove this adaptor from the unit.



### Removing the card

- 1 Press on the center of the card.
- 2 Pull it straight out.

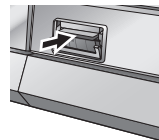

### Closing the cover

Push up.

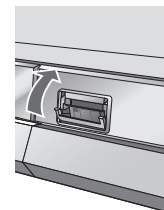

- You can use SD Memory Cards with capacities from 8 MB to 1 GB (→ 9).

**Keep the small memory cards such as the SD Memory Card out of reach of children. If swallowed, seek medical advice immediately.**

## Restrictions with DVD-R, etc.\*

Playing the disc on other DVD players is not possible before finalizing (⇒ 52).

16:9 aspect programs are recorded in 4:3 aspect.

The Main or SAP only can be recorded for MTS broadcasts.

\* DVD-R, DVD-RW and +R are collectively referred to as "DVD-R, etc." on this page.

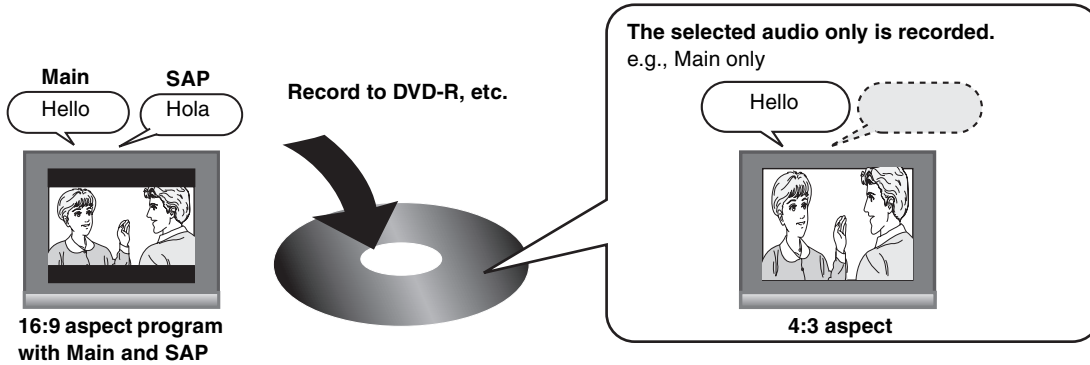

Therefore, follow the steps below when you use DVD-R, etc.

## ■ When recording an SAP program to DVD-R, etc.

Select the audio to record before recording or transferring (dubbing).

Some television programs are broadcast in SAP (Secondary Audio Program). You have to select the audio recording type before recording or transferring (dubbing) them to DVD-R, etc.

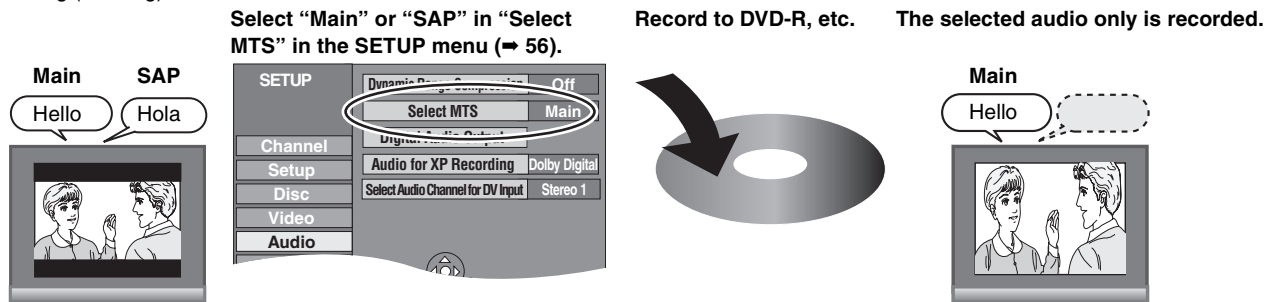

## ■ When you want to transfer (dub) titles in high speed mode from the HDD to DVD-R, etc.

Set "Rec. for High-Speed Dubbing" to "On" before recording to the HDD (⇒ 22).

You can transfer (dub) titles in high speed mode (max. speed is 64×); however, the following settings are necessary before recording to the HDD.

Set "Rec. for High-Speed Dubbing" to "On" (⇒ 22).



## ■ Playing the disc on other DVD players

The disc must be finalized after recording or transferring (dubbing) (⇒ 52).

It is necessary to finalize DVD-R, etc. on this unit after recording or transferring (dubbing) titles to them. You can then play them as a commercially sold DVD-Video. However, the discs become play-only and you can no longer record or transfer (dub).\*

\* You can record and transfer (dub) again if you format DVD-RW.

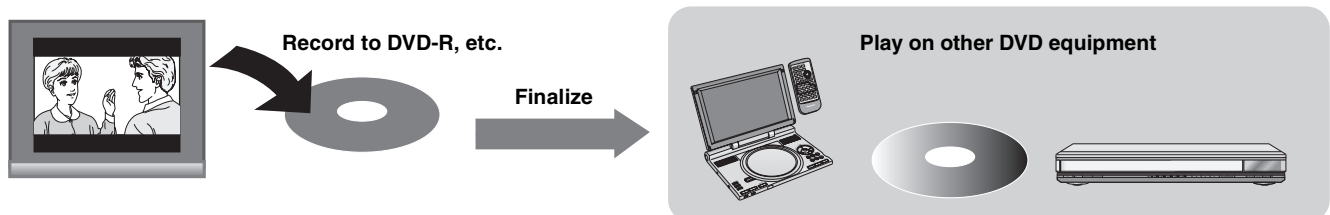

# Accessories



Please check and identify the supplied accessories. Use numbers indicated in parentheses when asking for replacement parts. (Product numbers correct as of May 2005. These may be subject to change.)

**To order accessories, call the dealer from whom you have made your purchase.**



1 **Remote control**  
(EUR7729KB0)

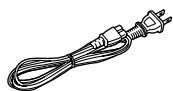

1 **AC power supply cord**  
(K2CB2CB00018)

- For use with this unit only. Do not use it with other equipment. Also, do not use cords for other equipment with this unit.



1 **75  $\Omega$  coaxial cable**  
(K2KZ2BA00001)

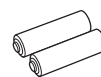

2 **Batteries**  
for remote control



1 **Audio/video cable**  
(K2KA6BA00003)



1 **IR Blaster**  
(K2ZZ04C00001)



1 **DVD-RAM disc**

## The remote control

### ■ Batteries

- Insert so the poles (+ and -) match those in the remote control.

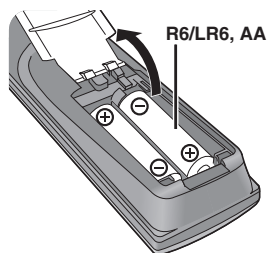

- Do not use rechargeable type batteries.
- Do not mix old and new batteries.
- Do not use different types at the same time.
- Do not heat or expose to flame.
- Do not take apart or short circuit.
- Do not attempt to recharge alkaline or manganese batteries.
- Do not use batteries if the covering has been peeled off.

Mishandling of batteries can cause electrolyte leakage which can damage items the fluid contacts and may cause a fire.

Remove batteries if the remote control is not going to be used for a long period of time. Store in a cool, dark place.

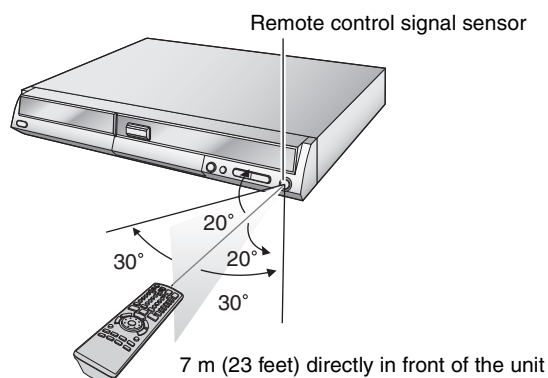

### ■ Use



## HDD and discs you can use for recording and play

(Chart continues on page 9.)

Getting started

Disc type	Hard disk drive (HDD) ●200 GB	DVD-RAM ●4.7 GB/9.4 GB, 12 cm (5") ●2.8 GB, 8 cm (3")	DVD-R (DVD-Video format) ●4.7 GB, 12 cm (5") ●1.4 GB, 8 cm (3")
Logo	—		
Indicated in these instructions by	<b>HDD</b>	<b>RAM</b>	<b>-R</b> before finalization <b>DVD-V</b> after finalization
Data that can be recorded and played	Video Still pictures	Video Still pictures	Video
Main use	Temporary storage	As re-writable discs for backup use	As one time recording discs for backup use (recordable until the disc is full)
Maximum recording time	Approx. 355 hours	Approx. 8 hours (Approx. 16 hours on a double-sided disc*)	Approx. 8 hours
Play on other players	—	Only on DVD-RAM compatible players.	Only after finalizing the disc (⇒ 52, 68).
Compatible with high speed recording	—	Up to 5× recording speed discs.	Up to 8× recording speed discs.
What you can do on this unit	Yes	Yes	No
Chasing playback	Yes	Yes	No
Recording broadcasts that allow one copy	Yes	Yes [CPRM (⇒ 68) compatible discs only.]	No
Recording both Main and SAP for MTS broadcasts	Yes	Yes	No Only one is recorded. (⇒ 56, Select MTS)
Recording 16:9 aspect picture	Yes	Yes	No (The picture is recorded in 4:3 aspect.)
Entering text	Yes	Yes	Yes
Erasing titles	Yes	Yes	Yes (Available space does not increase after erasing.)
Creating playlists	Yes	Yes	No

\* You cannot consecutively record or play both sides.

### Note

When "Rec. for High-Speed Dubbing" is set to "On", the restrictions on secondary audio recording, etc. are also applied to DVD-RAM. Turn this setting "Off" if high speed transfer (dubbing) to DVD-R, etc. is not necessary when recording a program (⇒ 22).

### ■ DVD Video Recording format

This is a recording method which allows you to record and edit television broadcasts and so on.

- Digital broadcasts that allow "One time only recording" can be recorded to a CPRM compatible disc. You can record to the HDD or CPRM compatible DVD-RAM on this unit.
- Play is only possible on a compatible DVD player.

Use the HDD or a DVD-RAM to record in DVD Video Recording format.

### ■ DVD-Video format



This recording method is the same as commercially available DVD-Video.

- Digital broadcasts that allow "One time only recording" cannot be recorded.
- These can be played on a DVD player. However programs recorded on this unit must be finalized to be played on other DVD players.

Use a DVD-R or DVD-RW to record in DVD-Video format.

## Play-only discs [12 cm (5")/8 cm (3")]

(Chart continues on page 9.)

Disc type	DVD-Video	DVD-Audio	DVD-RW (DVD Video Recording format)	+RW
Logo				—
Indicated in these instructions with	<b>DVD-V</b>	<b>DVD-A</b>	<b>-RW(VR)</b>	<b>DVD-V</b>
Instructions	High quality movie and music discs	High fidelity music discs ● Played on this unit in 2 channels	DVD-RW recorded on another DVD Recorder* ● You can play programs that allow "One time only recording" if they have been recorded to a CPRM compatible disc. ● By formatting (⇒ 51) the disc, you can record to it in DVD-Video format and play it on this unit. ● It may be necessary to finalize the disc on the equipment used for recording.	+RW recorded on another DVD Recorder*

- You can play still pictures (JPEG/TIFF), CD-DA, Video CD and MP3 format data recorded on CD-R/RW. Close the session or finalize the disc after recording.
  - The producer of the disc can control how discs are played. So you may not always be able to control play as described in these operating instructions. Read the disc's instructions carefully.
- \* Play may be impossible on some CD-R, CD-RW, DVD-RW or +RW discs due to the condition of the recording.

### Regarding DVD-Audio

Some multi-channel DVD-Audio will prevent down-mixing (⇒ 68) of all or part of their contents if this is the manufacturer's intention. Tracks that are prevented from being down-mixed will not play properly on this unit (e.g. audio is played from the front two channels only). Refer to the disc's jacket for more information.



## Cards useable on this unit

Type	SD Memory Card miniSD™ Card* MultiMediaCard
Indicated in these instructions by	<b>SD</b>
Data that can be recorded and played	Still pictures
Instructions	<p>You can insert directly into the SD card slot.</p> <p>* A miniSD™ card adaptor included with the miniSD™ card is necessary.</p> <ul style="list-style-type: none"> <li>You can play and transfer (dub) still pictures taken on a digital camera, etc. (➔ 34, 48).</li> <li>You can set the DPOF (Digital Print Order Format) for automatic printing on your home printer or at a photo developing store (➔ 42, 68).</li> </ul>

• **Compatible with:** FAT 12 or FAT 16

### Suitable SD Memory Cards

• You can use SD Memory Cards with the following capacities (from 8 MB to 1 GB).

<b>8 MB, 128 MB,</b>	<b>16 MB, 256 MB,</b>	<b>32 MB, 512 MB,</b>	<b>64 MB, 1 GB (Maximum)</b>
--------------------------	---------------------------	---------------------------	----------------------------------

- Useable memory is slightly less than the card capacity.
- Please confirm the latest information on the following website.  
<http://panasonic.co.jp/pavc/global/cs>  
(This site is in English only.)
- If the SD Memory Card is formatted on other equipment, the time spent for recording may become longer. Also if the SD Memory Card is formatted on a PC, you may not be able to use it on this unit. In these cases, format the card on this unit (➔ 51, 68).
- This unit supports SD Memory Cards formatted in FAT 12 system and FAT 16 system based on SD Memory Card Specifications.
- We recommend using a Panasonic SD card.

### Structure of folders displayed by this unit

The following  can be displayed on this unit.

\*\*\*: Numbers      XXX: Letters

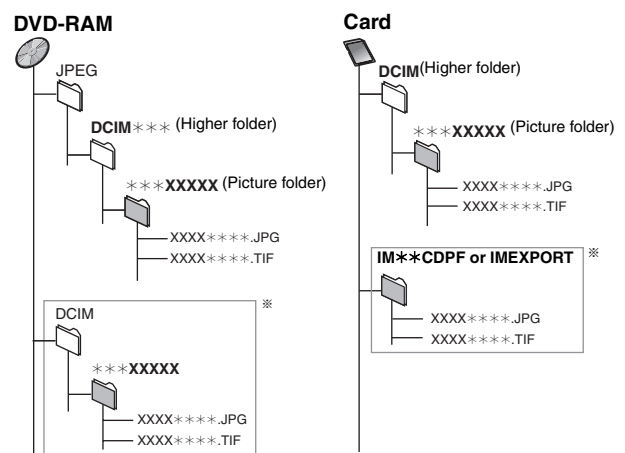



- \* Folders can be created on other equipment. However, these folders cannot be selected as a transferring (dubbing) destination.
- The folder cannot be displayed if the numbers are all "0" (e.g., DCIM000 etc).
- If a folder name or file name has been input using other equipment, the name may not be displayed properly or you may not be able to play or edit the data.

(Chart continues from page 8.)

DVD-RW (DVD-Video format) • 4.7 GB, 12 cm (5") • 1.4 GB, 8 cm (3")	+R • 4.7 GB, 12 cm (5")
	-
<b>-RW(V)</b> before finalization	<b>+R</b> before finalization
<b>DVD-V</b> after finalization	<b>DVD-V</b> after finalization
Video	Video
As re-writable discs for backup use	As one time recording discs for backup use (recordable until the disc is full)
Approx. 8 hours	Approx. 8 hours
Only after finalizing the disc (➔ 52, 68).	Only after finalizing the disc (➔ 52, 68).
Up to 4× recording speed discs.	Up to 8× recording speed discs.
No	No
No	No
No Only one is recorded. (➔ 56, Select MTS)	No Only one is recorded. (➔ 56, Select MTS)
No (The picture is recorded in 4:3 aspect.)	No (The picture is recorded in 4:3 aspect.)
Yes	Yes
Yes (Disc space increases only when the last recorded title is erased.)	Yes (Available space does not increase after erasing.)
No	No

- We recommend using Panasonic discs and cards. We also recommend using DVD-RAM discs with cartridges to protect them from scratches and dirt.
- Discs from other manufacturers may not be recorded or played due to the condition of the recording.
- You may not be able to record to DVD-R, DVD-RW and +R discs on this unit or play them due to the condition of the recording.
- You cannot record programs that allow "One time only recording" to CPRM compatible DVD-R and DVD-RW on this unit. You can record other programs as DVD-Video format.

(Chart continues from page 8.)

CD	Video CD
	
<b>CD</b>	<b>VCD</b>
Recorded audio and music (including CD-R/RW*)	Recorded music and video (including CD-R/RW*)
CD-R and CD-RW* with music recorded in MP3 (➔ 33) Still pictures (JPEG and TIFF) recorded on CD-R/RW*	

### Discs that cannot be played

- 2.6 and 5.2 GB DVD-RAM, 12 cm (5")
- 3.95 and 4.7 GB DVD-R for Authoring
- DVD-R recorded in DVD Video Recording format
- DVD-R (DVD-Video format), DVD-RW (DVD-Video format), +R recorded on another unit and not finalized (➔ 68).
- PAL discs (you can still play the audio on DVD-Audio)
- DVD-Video with a region number other than "1" or "ALL"
- Blu-ray
- DVD-ROM, DVD-R DL, +R DL, +R 8 cm (3"), CD-ROM, CDV, CD-G, Photo CD, CVD, SVCD, SACD, MV-Disc, PD, DivX Video Disc, etc.

### Note about using a DualDisc

The digital audio content side of a DualDisc does not meet the technical specifications of the Compact Disc Digital Audio (CD-DA) format so play may not be possible.

## Remote control

Instructions for operations are generally described using the remote control.

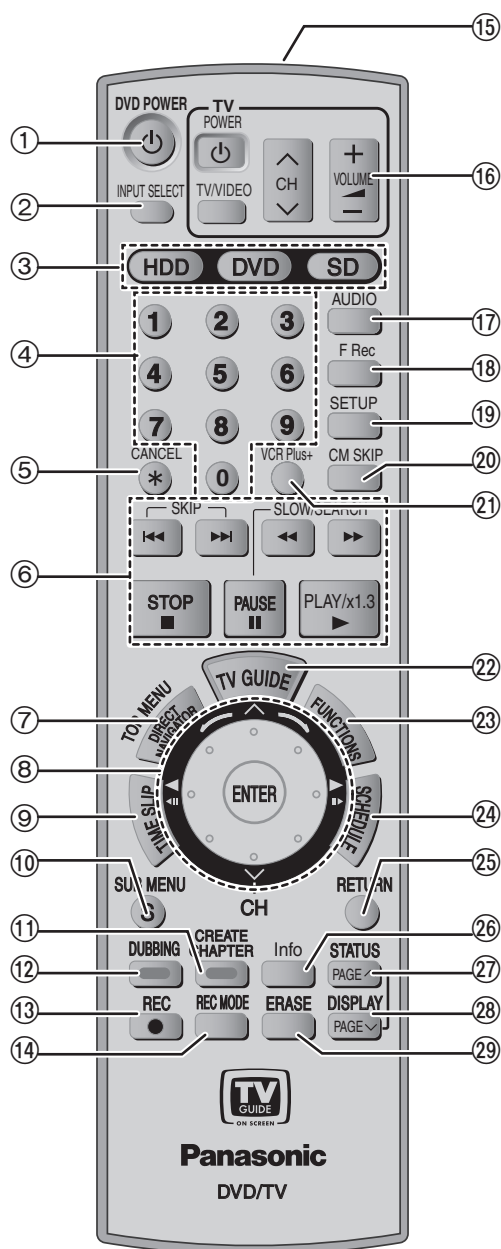

- ① Turn the unit on (⇒ 16)
- ② Input select (IN1, IN2, IN3 or DV) (⇒ 47)
- ③ Select drive (HDD, DVD or SD) (⇒ 20, 30, 34)
- ④ Select channels and title numbers, etc./Enter numbers
- ⑤ Cancel
- ⑥ Basic operations for recording and play
- ⑦ Show Top menu/Direct Navigator (⇒ 30, 38)
- ⑧ Smart Wheel (⇒ below)
- ⑨ Skip the specified time/Display the television image as a picture-in-picture (⇒ 23, 32)
- ⑩ Show sub menu (⇒ 38)
- ⑪ Create chapters (⇒ 32)
- ⑫ “Green” button for television program list (⇒ 24)
- ⑬ “Green” button for Direct Navigator (⇒ 34)
- ⑭ One touch transfer (dubbing) (⇒ 44)
- ⑮ “Blue” button for television program list (⇒ 24)
- ⑯ “Blue” button for Direct Navigator (⇒ 30)
- ⑰ Start recording (⇒ 20)
- ⑱ Change recording mode (⇒ 20)
- ⑲ Transmission window
- ⑳ Television operations (⇒ 19)
- ㉑ Select audio (⇒ 22, 32)
- ㉒ Start Flexible Recording (⇒ 23)
- ㉓ Show SETUP menu (⇒ 54)
- ㉔ Skip a minute forward (⇒ 32)
- ㉕ Show VCR Plus+ screen (⇒ 26)
- ㉖ Show television program list (TV Guide On Screen™ system) (⇒ 24)
- ㉗ Show FUNCTIONS window (⇒ 37)
- ㉘ Show scheduled recording list (⇒ 25)
- ㉙ Return to previous screen
- ㉚ Changing the size of information window (⇒ 28)
- ㉛ Show status messages/Skip one page upward (⇒ 37, 16)
- ㉜ Show on-screen menu/Skip one page downward (⇒ 36, 16)
- ㉝ Erase items (⇒ 32)

### Note

- Buttons such as the [● REC] button do not protrude as much as other buttons to stop them from being pressed accidentally.
- The word “button” is not used in these operating instructions so “Press the [ENTER] button.” is shown as “Press [ENTER].”
- You can use this remote control to operate your television if you set the television manufacturer code (⇒ 19).

### Smart Wheel operation

- Select items on menu screens and set items.

Press up, down, left or right to select an item.

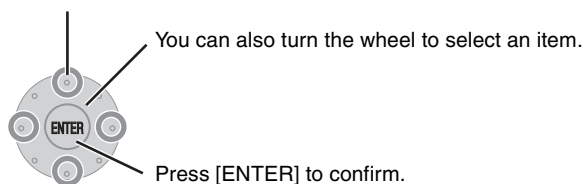

These operations are also possible.....

- Changing channels: Press [^] or [v] (up/down)
- Frame-by-frame (backward/forward): Press [◀▶] or [▶▶] (left/right)
- Forward search/slow-motion: Turn right
- Backward search/slow-motion: Turn left

### Note

Press the Smart Wheel lightly when turning it.

If you press it strongly when turning it, [▲, ▼, ◀, ▶] may be mistakenly activated.

## Main unit

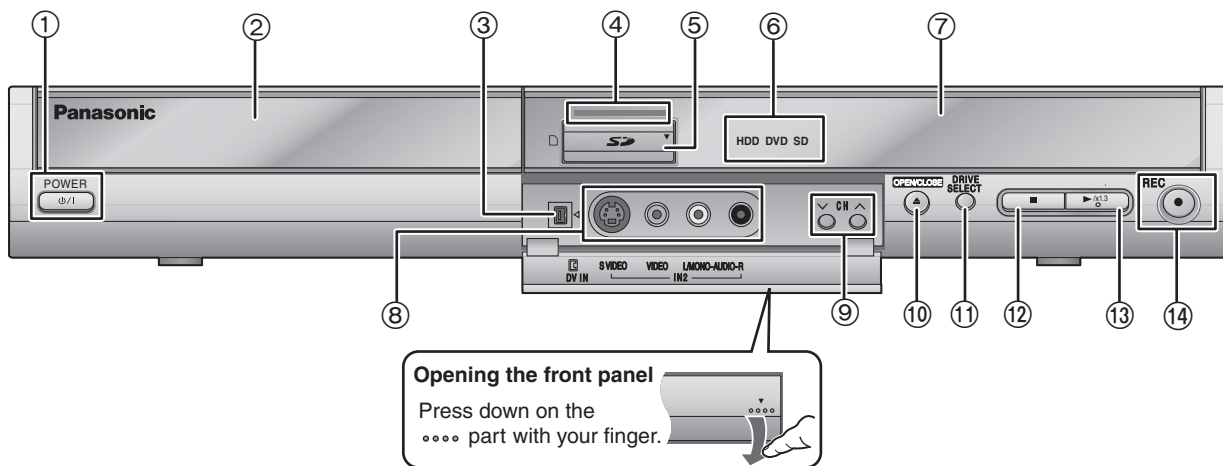

- ① **POWER button (POWER  $\text{\textcircled{I}}$ )** (⇒ 16)  
Press to switch the unit from on to standby mode or vice versa. In standby mode, the unit is still consuming a small amount of power.
- ② Disc tray (⇒ 20, 30)
- ③ Connector for a digital video (DV) camcorder (⇒ 47)
- ④ Lights when the unit is turned on (if “Front Display” is set to “Bright” ⇒ 56)
- ⑤ SD card slot (⇒ 5)
- ⑥ Lights when the HDD, DVD or SD drive is selected
- ⑦ Display (⇒ below)
- ⑧ Connectors for external equipment (⇒ 47)
- ⑨ Channel select (⇒ 20)
- ⑩ Open/close disc tray (⇒ 20, 30)
- ⑪ Select drive (⇒ 20, 30, 34)  
Drive changes each time you press [DRIVE SELECT].
- ⑫ Stop (⇒ 20, 30)
- ⑬ Start play (⇒ 30)
- ⑭ Start recording/Remote control signal sensor (⇒ 20)  
Specify the time to stop recording (⇒ 21)

Rear panel terminals (⇒ 12)

## The unit's display

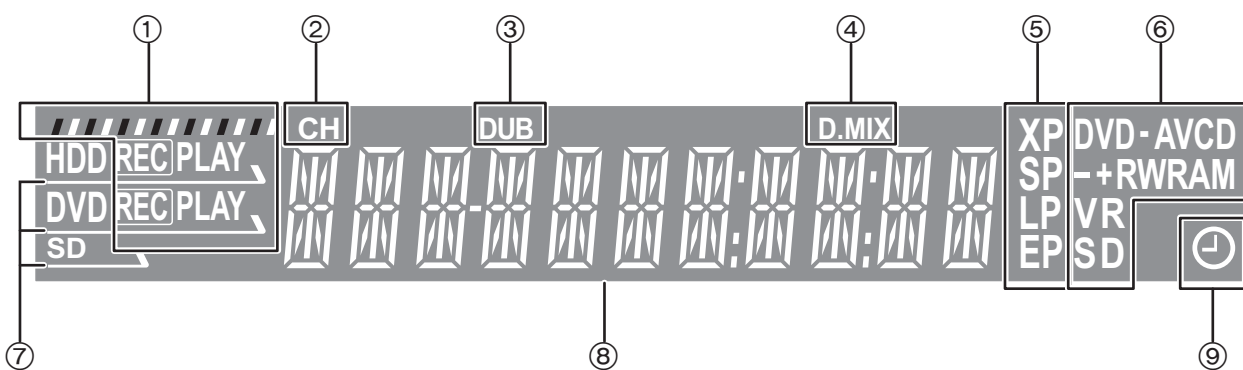

- ① e.g., **HDD**  

Recording	Playback	Recording/Playback
- ② Channel
- ③ Transferring (dubbing) indicator
- ④ D.MIX (multi-channel DVD-Audio only)  
When lit: Down-mixing (⇒ 68) is possible.  
When off: The disc prevents down-mixing so only the two front channels can be played (⇒ 8, Regarding DVD-Audio).
- ⑤ Recording mode
- ⑥ Disc type
- ⑦ Lights when the HDD, DVD or SD drive is selected
- ⑧ Main display section
- ⑨ Scheduled recording indicator

# STEP 1 Connection

- The equipment connections described are examples. Visit Panasonic's homepage for more information about connection methods. (This is in English only.)  
[http://www.panasonic.com/consumer\\_electronics/dvd\\_recorder/dvd\\_connection.asp](http://www.panasonic.com/consumer_electronics/dvd_recorder/dvd_connection.asp)
- Before connection, turn off all equipment and read the appropriate operating instructions.
- Peripheral equipment and optional cables sold separately unless otherwise indicated.

## Connection with a television and video cassette recorder

The connection will allow the video cassette recorder to be used for playback when this unit is turned off. For optimum operation, it is recommended that this unit be connected as shown below.

- Connection for transferring (dubbing) from video tape (➡ 14)

### To enjoy even higher picture quality

You can enjoy even higher picture quality, if your television has an S VIDEO IN or COMPONENT VIDEO IN terminals. (➡ 14)

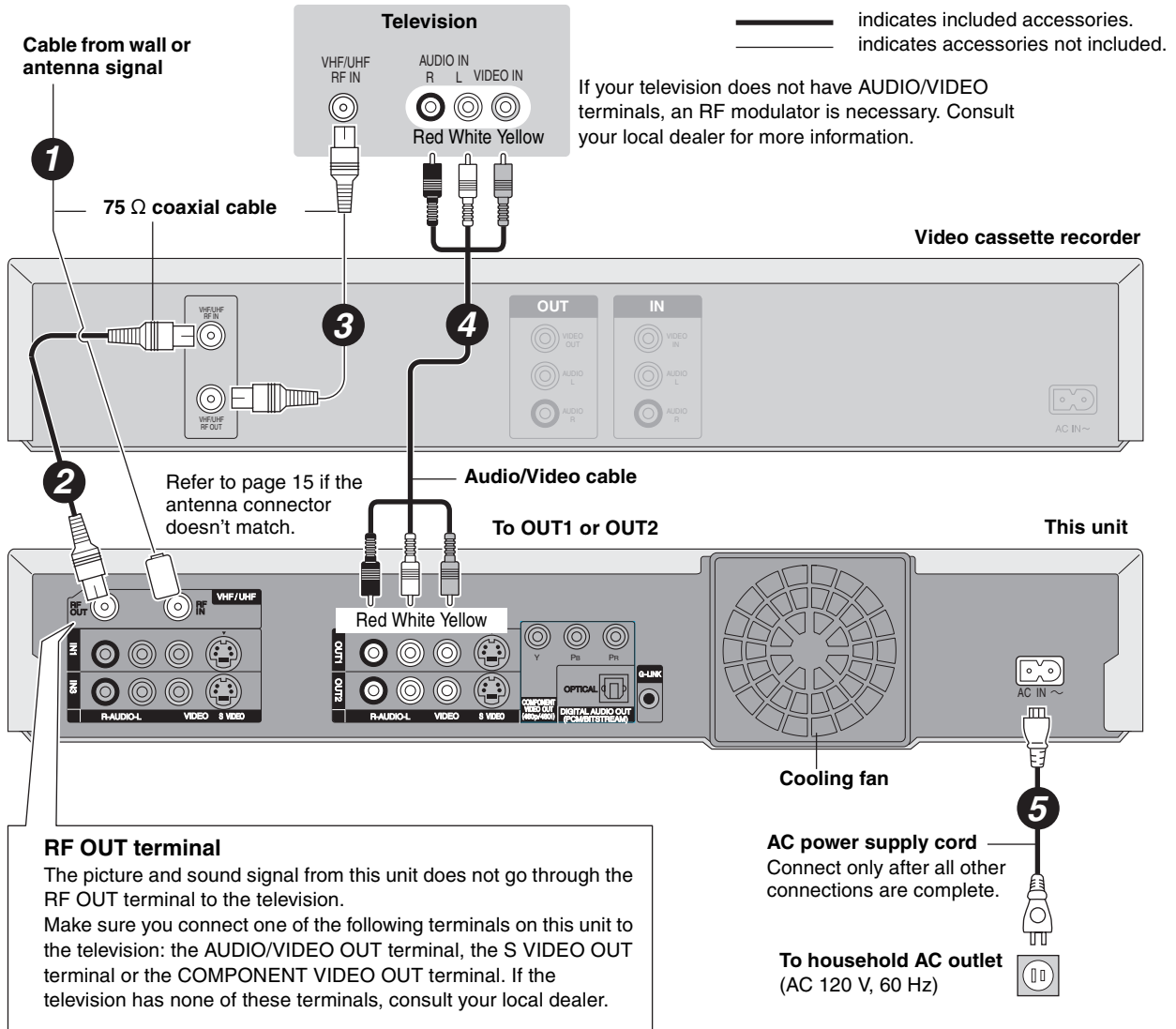

### 1 Sec. Quick Start for Recording & EPG Display

From the power on, recording starts in about 1 second\* after the REC button is pressed. If the TV GUIDE button is pressed while the unit is off, the Electronic Program Guide (EPG) starts displaying in less than 1 second, with the full EPG displaying in about 1.5 seconds.

\*Only when recording to the HDD or DVD-RAM

Note that the television program list is not downloaded while the unit is unplugged.

### When the unit is not to be used for a long time

To save power, unplug it from the household AC outlet. This unit consumes a small amount of power, even when it is turned off (approx. 13.7 W).

### Connect the unit directly to the television

If you connect the unit through an AV selector or video cassette recorder to the television, video signal will be affected by copyright protection systems and the picture may not be shown correctly.

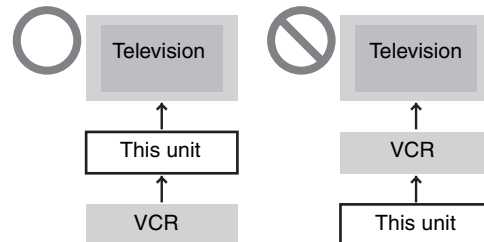

### When connecting to a television with a built-in VCR

Connect to the input terminals on the television side if there are both television and VCR input terminals.

## Connection with a cable TV box and video cassette recorder

- You need to subscribe to a cable TV service to enjoy viewing their programming.
- Consult your service provider regarding appropriate cable TV box.
- If you receive your programming solely from a satellite service, the program guide in this unit will not receive program listings or channel information. Without this information, program-based recordings cannot be made. However, recordings can still be set manually.

The connection will allow the video cassette recorder to be used for playback when this unit is turned off. For optimum operation, it is recommended that this unit be connected as shown below.

- Connection for transferring (dubbing) from video tape (➔ 14)

### To enjoy even higher picture quality

You can enjoy even higher picture quality, if your television has an S VIDEO IN or COMPONENT VIDEO IN terminals. (➔ 14)

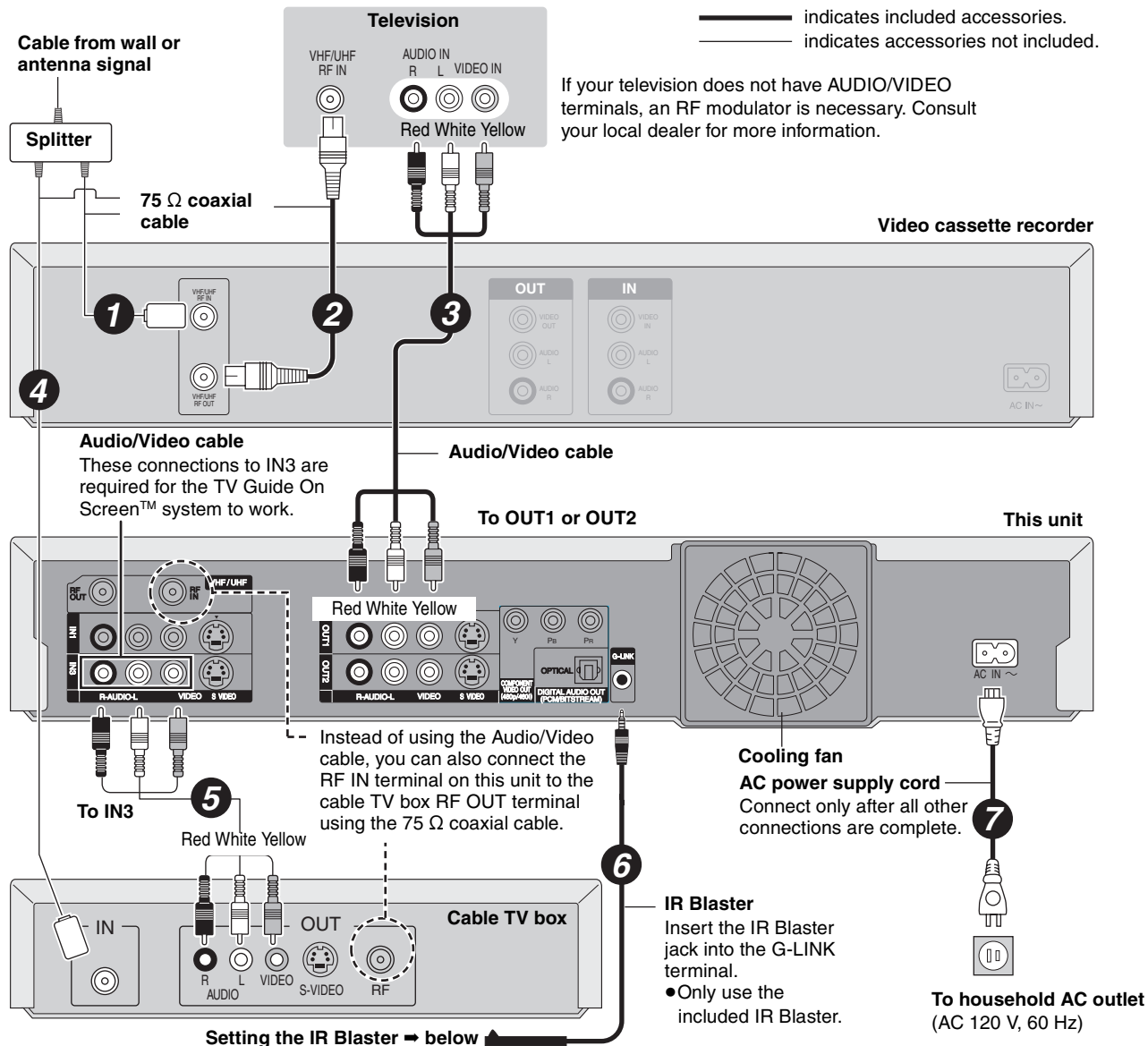

### Should I use the AUDIO/VIDEO OUT terminal or the RF OUT terminal?

If your cable TV box has both AUDIO/VIDEO OUT terminals and RF OUT terminals, we recommend connecting the AUDIO/VIDEO OUT terminal with the unit's IN3 terminal. Using this connection provides the better picture quality.

- The S VIDEO terminal achieves a more vivid picture than the VIDEO terminal.

### Why should I connect the IR Blaster?

To download program listings, the TV Guide On Screen™ system needs to be able to change channels on your cable box when the unit is not in use. Please connect the supplied IR Blaster cable to the G-LINK jack of the unit. After you connect the IR Blaster cable you will be able to control your cable box using the unit's remote control.

#### Setting the IR Blaster

Place the IR Blaster in front of the signal sensor of the cable TV box.

Read the cable TV box operating instructions regarding positioning of the signal sensor.

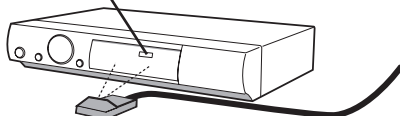

If necessary, use the double sided adhesive tape (included) to secure the IR Blaster to a flat surface.

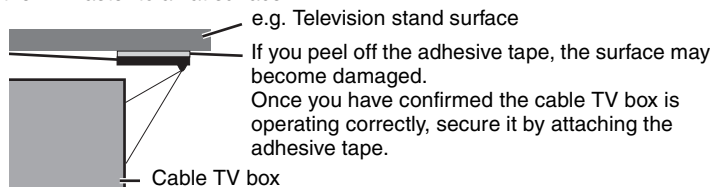

# STEP 1 Connection

## Connection for transferring (dubbing) from video tape

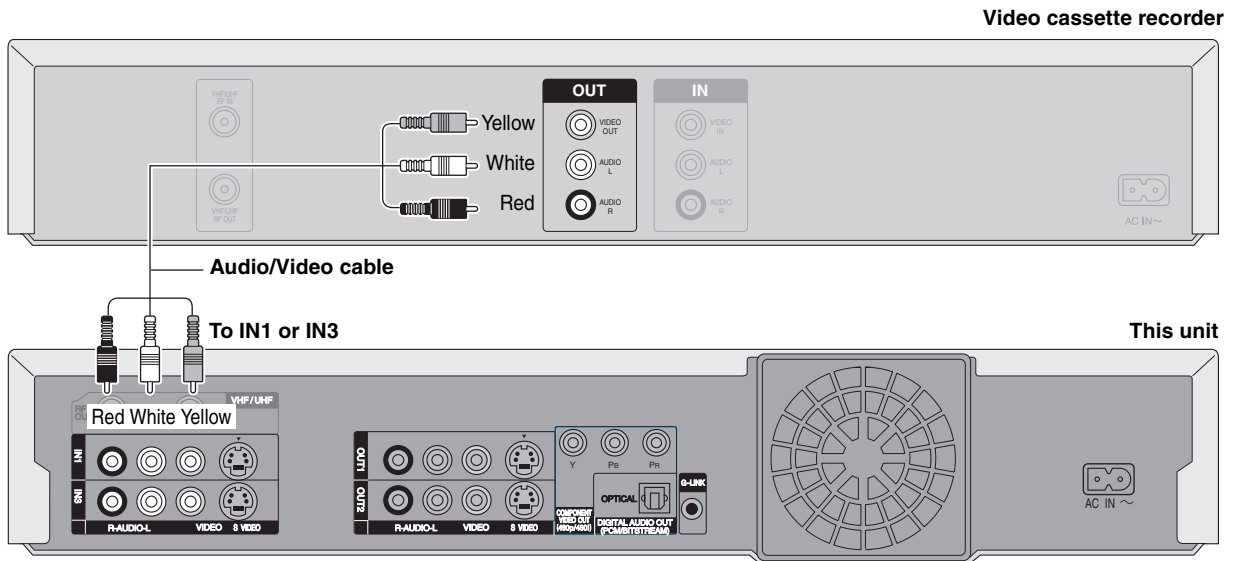

- To reduce video tape noise while transferring (dubbing)  
 ➔ 37, On-screen menu, Video, Line-in NR

## To enjoy even higher picture quality

### Connecting to the S VIDEO IN terminal

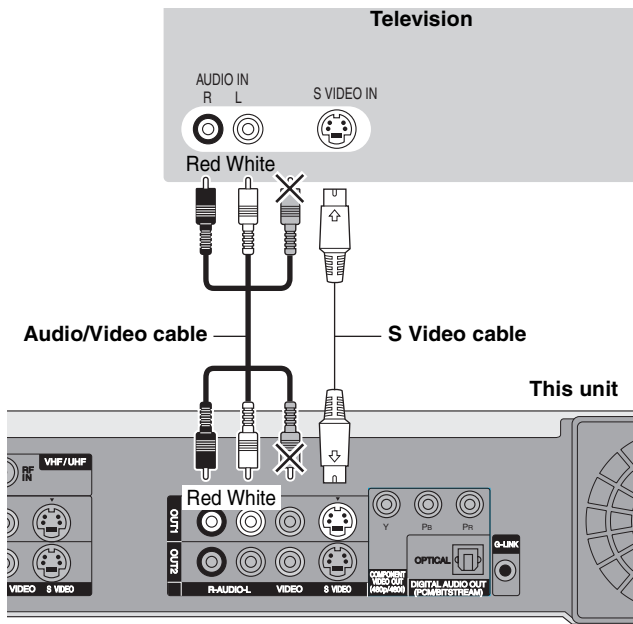

### S VIDEO OUT terminal

The S VIDEO OUT terminal achieves a more vivid picture than the VIDEO OUT terminal. (Actual results depend on the television.)

### Connecting to the COMPONENT VIDEO IN terminals

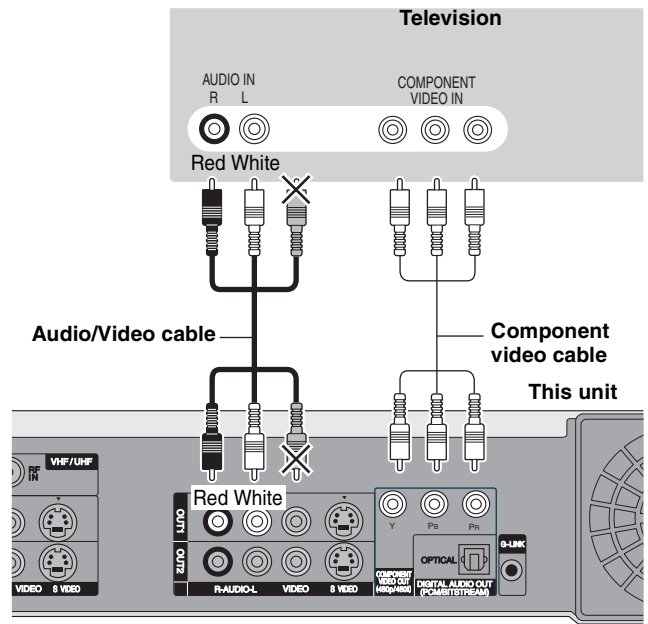

### COMPONENT VIDEO OUT terminal

These terminals can be used for either interlace or progressive output (➔ 68) and provide a purer picture than the S VIDEO OUT terminal.

- Connect to terminals of the same color.

## Connecting an amplifier or system component

### ■ Connection to a stereo amplifier

### ■ To enjoy multi-channel surround sound on DVD-Video

Connect an amplifier with a built-in decoder displaying these logo marks using an optical digital audio cable and change the settings in "Digital Audio Output" (→ 56).



- You cannot use DTS Digital Surround decoders not suited to DVD.

- Even if using this connection, output will be only 2 channels when playing DVD-Audio.

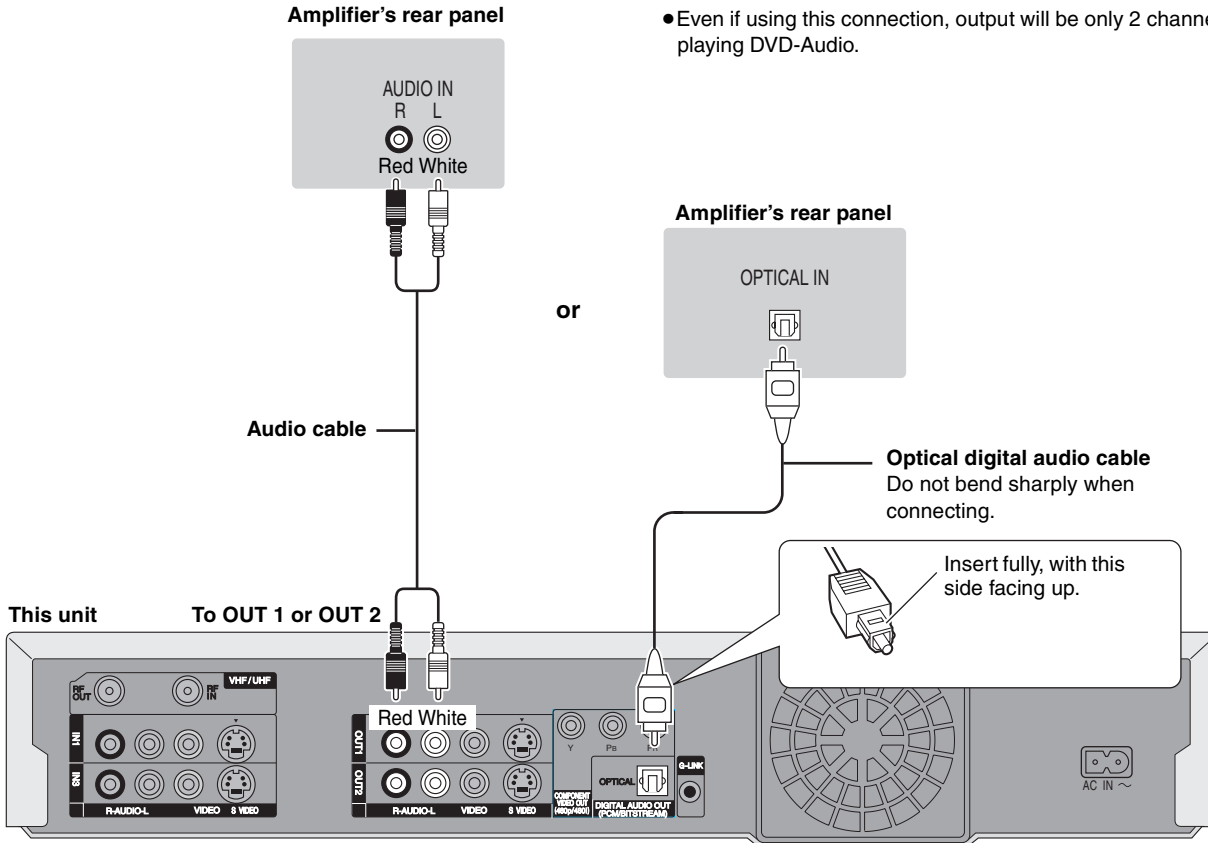

## If the antenna connector doesn't match

### Other antenna connections to the unit

Use one of the following connections to suit the antenna lead.

- If your television has both lead and coaxial VHF terminals, use the lead connection to minimize signal loss.

#### ■ A single twin lead

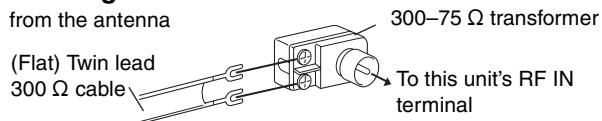

#### ■ A twin lead and a coaxial cable

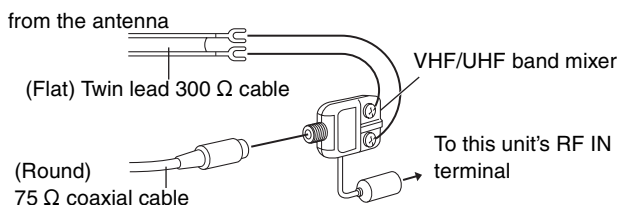

#### ■ Two twin leads

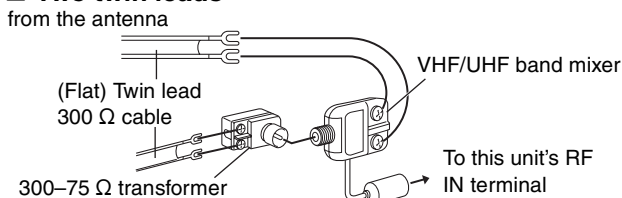

### Other antenna connections to the television

Use one of the following connections to suit the antenna terminals on your television. Refer to the television's operating instructions.

#### ■ A twin lead and coaxial plug terminal

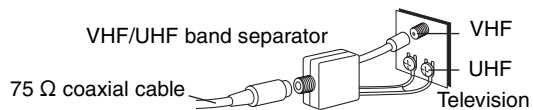

#### ■ A twin lead terminal



#### ■ Two twin lead terminals

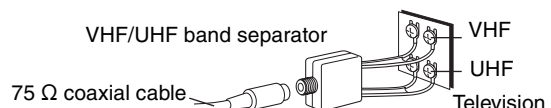

#### ■ Multiple antenna terminals

- Connect to one of the ANT terminals, then change the television's settings as necessary.

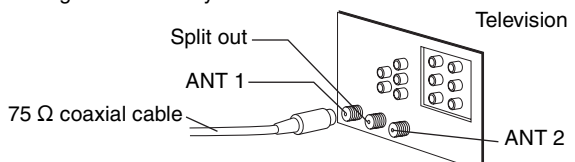

# STEP 2 Setting up the TV Guide On Screen™ system

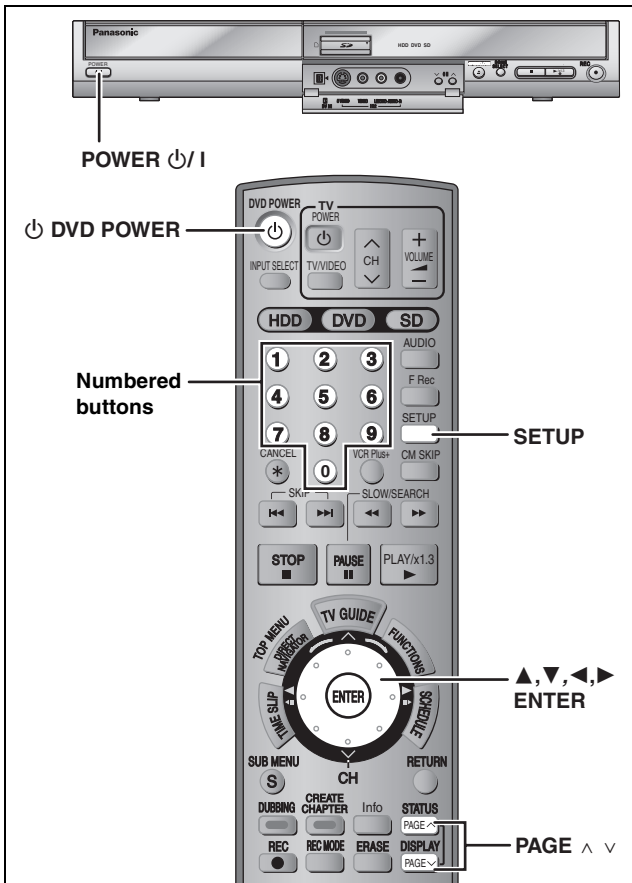

## 1 Press [DVD POWER].



## 2 Following the on-screen messages, input the operating environment for your television.

- Move the cursor using [▲, ▼, ◀, ▶] and press [ENTER] to confirm.
- Press the numbered buttons to enter numbers.
- Press [ENTER] to advance to the next screen.
- Refer to the instructions on the bottom of the screen.

### Set the following;

- Country (USA/Canada)

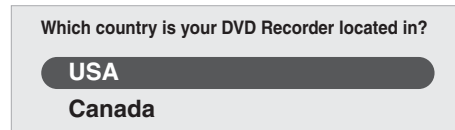

- Postal code

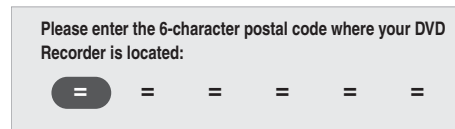

- Cable service connected to this unit (Yes/No)

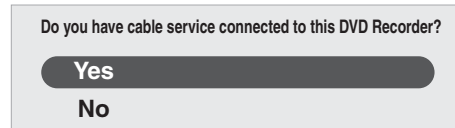

When "No" is selected, a confirmation screen is displayed (⇒ 17, "The set contents are displayed together").

- Cable TV box connected to this unit (Yes/No)

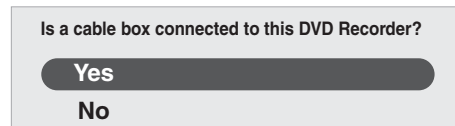

When "No" is selected, a confirmation screen is displayed (⇒ 17, "The set contents are displayed together").

**If you do not want to use the TV Guide On Screen™ system** Select "No" at this point even if a cable TV box is connected.

### If you are using a cable TV box, set the following:

- Cable TV box connection channel (Ch2/Ch3/Ch4/IN3)
  - If you are connecting the cable TV box to this unit's IN3 terminal, select "IN3".
  - If you are connecting the cable TV box to this unit's RF terminal, select "Ch2", "Ch3" or "Ch4", according to the cable TV box setting.
- Cable TV box brand
  - Move down with [▼] for more brands.
  - You can also press [PAGE ▲] or [PAGE ▼] to skip one page.
  - Select "Not Listed" if you cannot find your brand on the list.
- IR signal code
  - Make sure your cable TV box is set to the channel that appears on screen and press [ENTER].

Follow steps A and B below:

- Please tune your cable box to channel 02
- Make sure to leave your cable box turned ON

The unit begins trying various IR codes to see which one communicates properly with your cable TV box. It's quite common for this phase of the setup to be repeated numerous times.

After plugging the unit into your household AC outlet and pressing [DVD POWER] to turn the unit on for the first time, the unit starts TV Guide On Screen™ system setup.

**IMPORTANT: The TV Guide On Screen™ system must be setup whether it is then used or not. You cannot use the scheduled recording feature unless this setup is completed.**

**If you receive your programming solely from a satellite service, do steps 1-3 and "Set Clock Manually" (⇒ 17). The program guide in this unit will not receive program listings or channel information. Without this information, program-based recordings cannot be made. However, recordings can still be set manually.**

**Only English is displayed in the TV Guide On Screen™ system. Other languages cannot be displayed.**

### TV Guide On Screen™ system

This unit features the TV Guide On Screen™ system that provides an 8-day grid of TV programs available in your area. Use the TV Guide On Screen™ system to choose TV programs and simplify the recording of your favorite TV shows (⇒ 24, 28, 29). Best of all this service is free!

- The first time you download listings, you will receive the first few days of listings; however, not all 8 days. Listings for 8 days should be received within a few days.
- In order to cool the circuits used when downloading the television program list, the cooling fan may sometimes operate when the unit is turned off. This is not a malfunction.

### Note

**If you do not want to use TV Guide On Screen™ system, perform steps 1-3 and "Auto channel/clock settings" (⇒ 57)**

### Preparation

**Turn on the television and select the appropriate video input to suit the connections to this unit.**

- When using the cable TV box, check the following.
  - Make sure the IR Blaster is connected and positioned properly (⇒ 13).
  - Make sure the cable TV box is turned on.



Is your cable box now tuned to channel 09?

Yes

No

Test this code again

-If the cable TV box has changed to channel 09, select "Yes" and press [ENTER].

-If the cable TV box is still set to the same channel, select "No" and press [ENTER]. Repeat this step until the cable TV box changes to channel 09.

-If you want to try the code again for some reason, e.g., you accidentally moved the IR Blaster, select "Test this code again" and press [ENTER].

### ■ The set contents are displayed together

Postal code - L4W 2T3 (Canada)  
Cable - Yes  
Cable box - No

-If the information is correct, select "Yes, end setup" and press [ENTER].

-If the information is not correct, select "No, repeat setup process" and press [ENTER] to start the setting again.

Once you confirm the input content, the following screen appears.

What would you like to do now?

Watch TV

The above screen may not appear again if you repeat the setup process.

## 3 Press [ENTER].

A picture or a blue background screen is displayed.

**If you do not want to use TV Guide On Screen™ system**  
→ 57, Auto channel/clock settings

## 4 Press [⏻ DVD POWER].

"BYE" appears briefly and then "12:00A" flashes on the unit's display. This shows the unit is in standby mode. The unit is now ready to download the channel line-up and the program listings.

Check the following again, so the downloading will not fail.

**If you connect a cable TV box**

- the output terminal of the cable TV box is connected to this unit's RF IN or IN3 terminal (→ 13)

- the IR Blaster is correctly connected and installed (→ 13)

- the cable TV box is turned on

**If you do not connect a cable TV box**

- the antenna cable is connected to this unit's RF IN terminal (→ 12)

## 5 Leave this unit in the standby mode.

It is strongly recommended that you wait at least 24 hours before using the unit. No damage will occur if the unit is used sooner, but the channel line-up and program listings may not have been fully downloaded.

- If you connect a cable TV box, leave it switched on without using it.

- With some cable TV boxes, the cable TV box remote control can turn on and off both the cable TV box and the television. Utilizing this feature (turning the cable TV box off) will prevent the channel line-up from being downloaded.

- If the unit's display changes from flashing "12:00A" to the current time, you can manually set the scheduled recording (→ 25).

- If the unit's display does not change to the current time even after waiting, we recommend that you set the clock using "Set Clock Manually" (→ right).

If you find "There is no data for this screen" displayed on the television when you turn the unit on, the unit has not yet downloaded the channel line-up.

This unit may download more than one channel line-up. Follow the on-screen instructions and select one of these.



Leave the unit in standby mode when you are not using it. The unit will download the necessary data to maintain the listings while it is in standby mode.

Some menus in the SETUP screen no longer need to be set after this unit downloads the television program list. These menus turn grey and become un-selectable. (→ 54)

### To use immediately (Set Clock Manually)

Set the clock manually.

Please note that the program list is not displayed until the unit downloads it. Scheduled recording is only possible manually.

- 1 Press [SETUP].
- 2 Press [▲, ▼] to select "Setup" and press [▶].
- 3 Press [▲, ▼] to select "Clock Settings" and press [ENTER].
- 4 Press [▲, ▼] to select "Set Clock Manually" and press [ENTER].

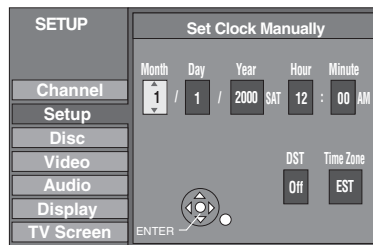

- 5 Press [◀, ▶] to select the item you want to change and press [▲, ▼] to change the setting.
- 6 Press [ENTER]. The clock starts.
- 7 Press [SETUP].

#### • DST (Daylight Saving Time): On or Off

If you select "On", the clock is advanced one hour starting at 2 a.m. on the first Sunday in April and ending at 2 a.m. on the last Sunday in October.

#### • Time Zone shows the time difference from Greenwich Mean Time (GMT).

EST (Eastern Standard Time) = GMT -5

CST (Central Standard Time) = GMT -6

MST (Mountain Standard Time) = GMT -7

PST (Pacific Standard Time) = GMT -8

AST (Alaska Standard Time) = GMT -9

HST (Hawaii Standard Time) = GMT -10

If further assistance is needed,  
Call 1-800-561-5505.

In the United States, TV GUIDE and other related marks are registered marks of Gemstar-TV Guide International, Inc. and/or one of its affiliates. In Canada, TV GUIDE is a registered mark of Transcontinental Inc., and is used under license by Gemstar-TV Guide International, Inc. TV Guide On Screen, G-LINK, VCR Plus+ and PlusCode are registered marks of Gemstar-TV Guide International and/or one of its affiliates.

The TV Guide On Screen and VCR Plus+ systems are manufactured under license from Gemstar-TV Guide International, Inc. and/or one of its affiliates.

**GEMSTAR-TV GUIDE INTERNATIONAL, INC. AND/OR ITS RELATED AFFILIATES ARE NOT IN ANY WAY LIABLE FOR THE ACCURACY OF THE PROGRAM SCHEDULE INFORMATION PROVIDED BY THE TV GUIDE ON SCREEN SYSTEM. IN NO EVENT SHALL GEMSTAR-TV GUIDE INTERNATIONAL, INC. AND/OR ITS RELATED AFFILIATES BE LIABLE FOR ANY AMOUNTS REPRESENTING LOSS OF PROFITS, LOSS OF BUSINESS, OR INDIRECT, SPECIAL, OR CONSEQUENTIAL DAMAGES IN CONNECTION WITH THE PROVISION OR USE OF ANY INFORMATION, EQUIPMENT, OR SERVICES RELATING TO THE TV GUIDE ON SCREEN SYSTEM.**

The TV Guide On Screen and VCR Plus+ systems are protected by one or more issued United States patents such as 6,331,877; 6,239,794; 6,154,203; 5,940,073; 4,908,713; 4,751,578; 4,706,121; 6,466,734; 6,430,359; 6,091,882; 6,049,652; 5,335,079; 5,307,173; 6,498,895; 6,418,556.

# STEP 3 Set up to match your television and the unit's remote control/Power saving function

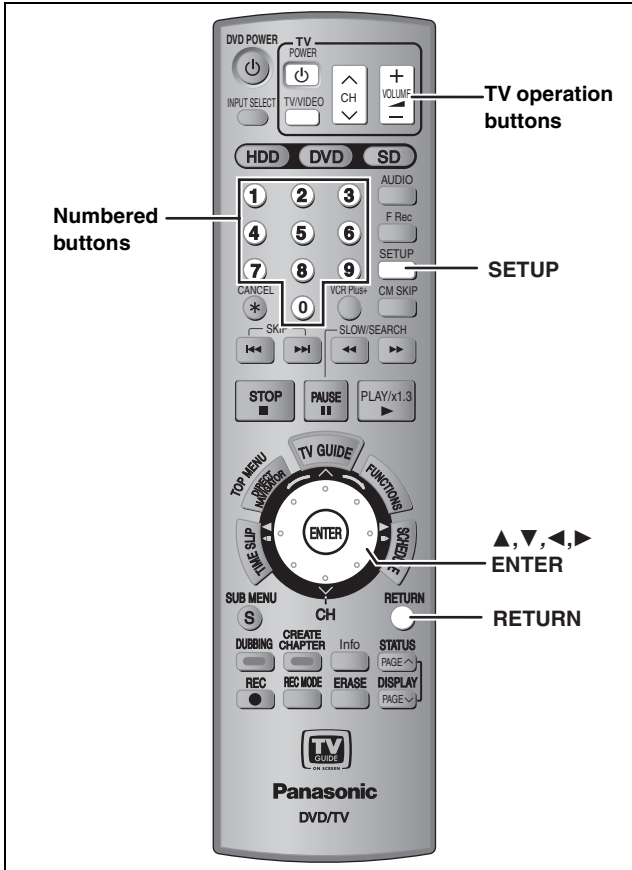

## Selecting television type

This setting allows you to select the type of television connected.

- 1 Press [SETUP].
- 2 Press [▲, ▼] to select "TV Screen" and press [▶].
- 3 Press [▲, ▼] to select "TV Type" and press [ENTER].

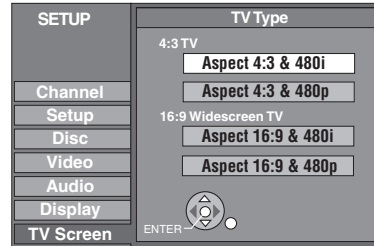

● Aspect 4:3/Aspect 16:9:



4:3 standard aspect television      16:9 widescreen television

- 480p/480i:
  - Select "480p" if the television is compatible with progressive output.
  - Select "480i" if the television is not compatible with progressive output or you are unsure about television compatibility.

- 4 Press [▲, ▼] to select the item and press [ENTER].

### To return to the previous screen

Press [RETURN].

### To exit the screen

Press [SETUP].

**When connected to a 4:3 standard aspect television**  
 To change how a DVD-Video or DVD-RAM widescreen picture is shown on a 4:3 standard aspect television  
 ➔ 56, "4:3 TV Settings for DVD-Video" or "4:3 TV Settings for DVD-RAM"

## Television operation

You can configure the remote control TV operation buttons to turn the television on/off, change the television input mode, select the television channel and change the television volume.

### 1 Point the remote control at the television

**While pressing [POWER TV] enter the code with the numbered buttons.**

e.g., 01: [0] → [1]    10: [1] → [0]

#### Manufacturer and Code No.

Panasonic National QUASAR	01/02	PHILIPS (RC-5)	03
		RCA	05
		SAMSUNG	14/18/19
FISHER	10	SANYO	10
GE	05	SHARP	06/07
GOLDSTAR	15/16/17	SONY	08
HITACHI	12	SYLVANIA	03
JVC	11	THOMSON	05
LG	15/16/17	TOSHIBA	09
MAGNAVOX	03	ZENITH	04
mitsubishi	13		

### 2 Test by turning on the television and changing channels.

- Repeat the procedure until you find the code that allows correct operation.
- If your television brand is not listed or if the code listed for your television does not allow control of your television, this remote control is not compatible with your television.

#### Note

- If your television brand has more than one code listed, select the one that allows correct operation.

## When other Panasonic products respond to this remote control

Change the remote control code on the main unit and the remote control (the two must match) if you place other Panasonic products close together.

Use "1", the factory set code, under normal circumstances.

- 1 Press [SETUP].
- 2 Press [▲, ▼] to select "Setup" and press [▶].
- 3 Press [▲, ▼] to select "Remote Control Code" and press [ENTER].
- 4 Press [▲, ▼] to select the code (1, 2, or 3) and press [ENTER].



- 5 To change the code on the remote control  
While pressing [ENTER], press and hold the numbered button ([1], [2] or [3]) for more than 2 seconds.
- 6 Press [ENTER].

- When the following indicator appears on the unit's display and you are unable to operate the unit



The unit's remote control code

Change the code on the remote control to match the main unit's (→ step 5).

#### To return to the previous screen

Press [RETURN].

#### To exit the screen

Press [SETUP].

## Power saving function

### ■ Off Timer

The unit switches to standby after about 6 hours in the stop mode. You can turn this feature off or change the time to 2 hours (→ 54, "Off Timer").

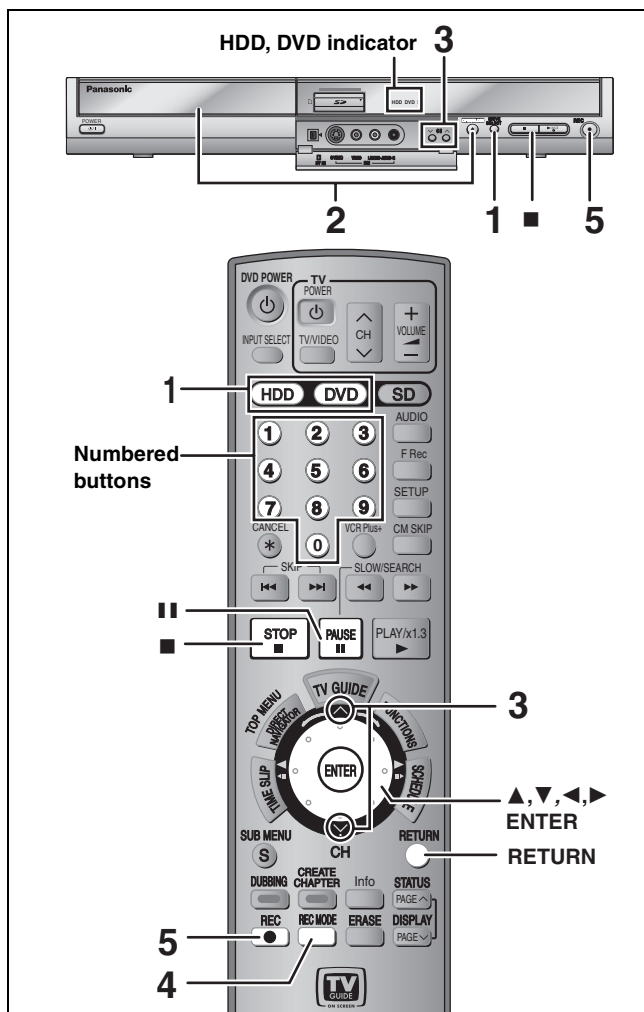

### HDD

- You can record up to 500 titles on HDD. (When continuously recording for long durations, titles are automatically divided every 8 hours.)

### RAM -R -RW(V)

- You can record up to 99 titles on one disc.

### +R

- You can record up to 49 titles on one disc.

### SD

- It is not possible to record onto a card.

### Preparation

- Turn on the television and select the appropriate video input to suit the connections to this unit.
- Turn on this unit.
- Press [RETURN] to exit the television program list if it is displayed on the television. To turn off auto start up of the television program list → 29, "Review options" menu

See also the notes "Before recording" (→ 21).

## 1 Press [HDD] or [DVD] to select the recording drive.

The HDD or DVD indicator lights up on the unit.

## 2 If you selected the DVD drive

Press [**▲ OPEN/CLOSE**] on the main unit to open the tray and insert a disc.

- Press the button again to close the tray.
- When using 8 cm (3") DVD-RAM or 8 cm (3") DVD-R, remove the disc from the cartridge.

Insert label-up.

### ■ Cartridge disc

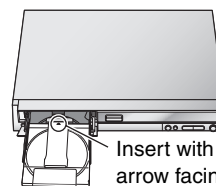
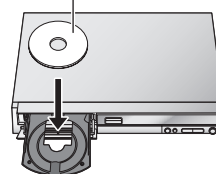

Insert with the arrow facing in.  
Insert fully so it clicks into place.

## 3 Press [**▲ ▼ CH**] to select the channel.



To select with the numbered buttons:

### Antenna Mode

- e.g., 5: [0] → [5]  
15: [1] → [5]

### CableTV Mode

- e.g., 5: [0] → [0] → [5]  
15: [0] → [1] → [5]  
115: [1] → [1] → [5]

- Select the audio to record (→ 22).

## 4 Press [REC MODE] to select the recording mode (XP, SP, LP, or EP).



Remaining time on the disc

- To record sound using LPCM (XP mode only):  
Set "Audio for XP Recording" to "LPCM" in the SETUP menu (→ 56).

## 5 Press [**● REC**] to start recording.



Recording will take place on open space on the HDD or on disc. Data will not be overwritten.

- You cannot change the channel or recording mode during recording. You can change the channel or recording mode while paused; however, the recording will then be as a separate title.

- You can record while the unit is in standby for scheduled recording, but once the time for the scheduled recording to begin is reached, any recording taking place will stop and the scheduled recording will begin.

### ■ To pause recording

Press [II].

Press again to restart recording.

You can also press [● REC] to restart.

(Title is not split into separate titles.)

### ■ To stop recording

Press [■].

- From the start to the end of the recording is called one title.

- R -RW(V) +R** It takes about 30 seconds for the unit to complete recording management information after recording finishes.

In order to play DVD-R, DVD-RW (DVD-Video format) and +R (recorded with this unit) on other DVD players, it is necessary to finalize them (→ 52).

## Recording modes and approximate recording times

Depending on the content being recorded, the recording times may become shorter than indicated.

(Unit: hour)

Mode	HDD (200 GB)	DVD-RAM		DVD-R DVD-RW +R (4.7 GB)
		Single- sided (4.7 GB)	Double- sided* <sup>1</sup> (9.4 GB)	
XP (High quality)	44	1	2	1
SP (Normal)	89	2	4	2
LP (Long play)	177	4	8	4
EP (Extra long play)	355 (266* <sup>2</sup> )	8 (6* <sup>2</sup> )	16 (12* <sup>2</sup> )	8 (6* <sup>2</sup> )
FR (Automatic mode selection)	355 hours maximum	8 hours maximum	8 hours maximum for one side	8 hours maximum

\*<sup>1</sup> It is not possible to record or play continuously from one side of a double sided disc to the other.

\*<sup>2</sup> When "Recording Time in EP Mode" is set to "EP (6H)" in the SETUP menu (⇒ 55).  
The sound quality is better when using "EP (6H)" than when using "EP (8H)".

● **RAM** When recording to DVD-RAM using EP (8H) mode, play may not be possible on DVD players that are compatible with DVD-RAM. Use EP (6H) mode if playback may be on other equipment.

### FR (Flexible Recording Mode)

You can set FR (Flexible Recording) mode when transferring (dubbing) or programming scheduled recordings. The unit automatically selects a recording rate between XP and EP (8H) that will enable the recordings to fit in the remaining disc space with the best possible recording quality. For example with a 90 minute recording to an unused DVD-RAM, the picture quality is adjusted to between "XP" and "SP".

- When recording to the HDD, picture quality is automatically adjusted to precisely fit a transferred (dubbed) title on a 4.7 GB disc.
- All the recording modes from XP to EP appear in the display.



## Before recording

- It is not possible to record to both HDD (Hard Disk Drive) and DVD drive simultaneously.
- It is not possible to record continuously from one side of a double sided disc to the other. You will need to eject the disc and turn it over.
- It is not possible to record digital broadcasts that allow "One time only recording" onto DVD-R, DVD-RW, +R or 8 cm (3") DVD-RAM discs. Use the HDD or CPRM compatible DVD-RAM.
- When transferring (dubbing) in high speed mode to DVD-R, DVD-RW (DVD-Video format) and +R, after you have recorded to the HDD, set "Rec. for High-Speed Dubbing" to "On" before recording to the HDD (⇒ 22).

### The Main or SAP only can be recorded for MTS broadcasts, when

- Recording to DVD-R, DVD-RW (DVD-Video format) and +R
- Recording sound in LPCM (⇒ 56, Audio for XP Recording)
- "Rec. for High-Speed Dubbing" is set to "On" (⇒ 22)

You have to select the audio recording type before recording.

–If you do not connect a cable TV box  
Select "Main" or "SAP" in "Select MTS" in the SETUP menu (⇒ 56).

–If you connect a cable TV box  
Select "Main" or "SAP" on the cable TV box.

## After recording

- **-R -RW(V) +R** In order to play a disc recorded using this unit on other playback equipment, the disc must first be finalized (⇒ 52).
- If the program is listed in the television program list (⇒ 28), its name is automatically made the title name after recording. (The recorded title must be more than 3 minutes.)

## To specify a time to stop recording—One Touch Recording

**HDD RAM -R -RW(V) +R**

### During recording

Press [● REC] to select the recording time.

- You can specify up to 4 hours later.
- The unit display changes as shown below.  
0:30 → 1:00 → 1:30 → 2:00 → 3:00 → 4:00  
← Counter (cancel) ←

- This does not work during scheduled recordings (⇒ 24) or while using Flexible Recording (⇒ 22).
- If you change the channel or recording mode while recording is paused, the time specified to stop recording is cancelled.
- The unit does not turn off automatically after the time to stop recording is reached.

### To cancel

- Press [● REC] several times until the counter appears.
- The time to stop recording is cancelled; however, recording continues.

### To stop recording partway

Press [■].

## Off Timer

The unit switches to standby after about 6 hours in the stop mode. You can turn this feature off or change the time to 2 hours (⇒ 54, "Off Timer").

## When using DVD-RW

When you insert a new DVD-RW or a DVD-RAM/DVD-RW (DVD-Video format) recorded on a computer or other equipment, a format confirmation screen is displayed. Format the disc to use it. However, all the recorded contents are erased.

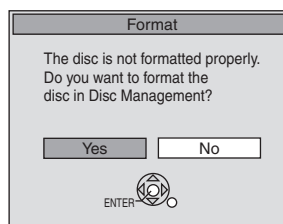

Press [◀] to select "Yes" and press [ENTER].

### To format a disc

"Erasing all the contents of a disc or card—Format" (⇒ 51)

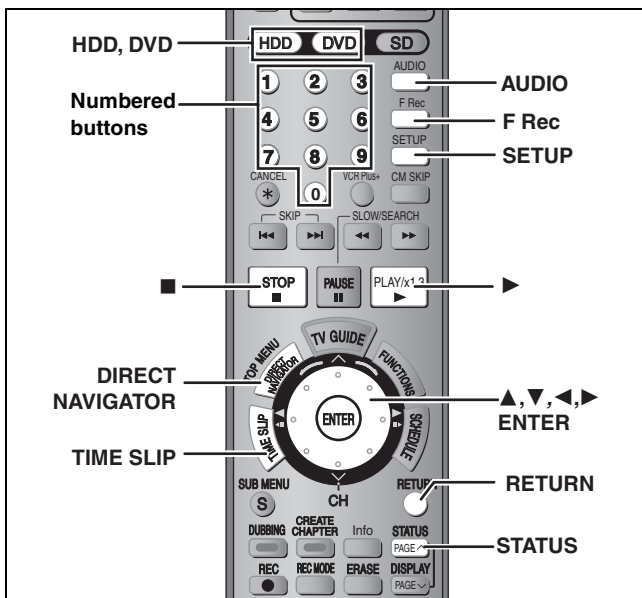

- 4 Press [**▲**, **▼**] to select “Rec. for High-Speed Dubbing” and press [ENTER].
- 5 Press [**▲**, **▼**] to select “On” and press [ENTER].
  - When recording MTS broadcasts (⇒ below)

**To return to the previous screen**  
Press [RETURN].

**To exit the screen**  
Press [SETUP].

**To start recording**

- Recording television program (⇒ 20)
- Scheduled recording (⇒ 24)
- Recording from a video cassette recorder (⇒ 47)

**When recording MTS broadcasts**

- If you do not connect a cable TV box  
Select “Main” or “SAP” in “Select MTS” in the SETUP menu (⇒ 56).
- If you connect a cable TV box  
Select “Main” or “SAP” on the cable TV box.

**However, the restrictions shown below apply when recording to the HDD**

- 16:9 aspect programs are recorded in 4:3 aspect.
  - Only the main or the secondary (SAP) audio is recorded when recording MTS broadcasts.
- Therefore, set “Rec. for High-Speed Dubbing” to “Off” if you do not intend to transfer (dub) titles in high speed mode to DVD-R, DVD-RW (DVD-Video format) and +R after you have recorded them to the HDD.**

**Selecting audio to record**

**HDD RAM**

Press [AUDIO].

- **Stereo:** Main audio (stereo)
    - If the broadcast is “Mono+ SAP”, audio will be monaural even if you select Stereo mode.
  - ↓
  - SAP:** Secondary audio program (SAP)
    - If recorded in SAP mode, main audio is also recorded.
  - ↓
  - Mono:** Main audio (monaural)
    - Select “Mono” if reception is poor during a stereo broadcast.
- e.g., “Stereo” is selected  
“(” appears when the unit is receiving the audio type you selected.

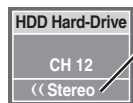

•If you change the sound setting while recording, the recorded sound will also change.

**Note**

- You cannot change the audio type in the following cases.
- When a DVD-R, DVD-RW (DVD-Video format) or +R is in the disc tray while DVD drive is selected.
  - When the recording mode is XP and “Audio for XP Recording” is set to “LPCM” (⇒ 56).
  - When “Rec. for High-Speed Dubbing” is set to “On” (⇒ below).

**-R -RW(V) +R**

**HDD RAM** (When recording sound in LPCM)

**HDD RAM** (When “Rec. for High-Speed Dubbing” is set to “On”)

**Select the audio (Main or SAP) in “Select MTS” in the SETUP menu (⇒ 56).**

**Recording for High-Speed Dubbing**

When you want to transfer (dub) titles in high speed mode to DVD-R, DVD-RW (DVD-Video format) and +R after having recorded them to the HDD, set “Rec. for High-Speed Dubbing” to “On” before recording to the HDD.

- 1 While stopped  
Press [SETUP].
- 2 Press [**▲**, **▼**] to select “Disc” and press [**▶**].
- 3 Press [**▲**, **▼**] to select “Settings for Recording” and press [ENTER].

**Flexible Recording**

(Recording that fits the remaining disc space)

**HDD RAM -R -RW(V) +R**

The unit sets the best possible picture quality that fits the recording within the remaining disc space. The recording mode becomes FR mode.

**Using “FLEXIBLE RECORDING” is convenient in these kinds of situations.**

**RAM -R -RW(V) +R**

- When the amount of free space on the disc makes selecting an appropriate recording mode difficult
- When you want to record a long program with the best picture quality possible

**HDD**

- When you want to record a title to HDD so that it can then be transferred (dubbed) to fit one 4.7 GB disc perfectly
- You do not need to edit the recorded title, or change the recording mode when transferring (dubbing), to fit the disc space.

e.g., Recording a 90 minute program to disc

If you select XP mode, the program will not fit one disc.



A second disc is necessary for 30 minutes of the program.

If you select SP mode, the program will fit one disc.



However there will be 30 minutes remaining disc space.

If you select “FLEXIBLE RECORDING” the program will fit one disc perfectly.



**Preparation**

- Select the channel or the external input (IN1, IN2, IN3 or DV) to record.
- Press [HDD] or [DVD] to select the recording drive.

**1 While stopped**

Press [F Rec].



**Maximum recording time**  
This is the maximum recording time in EP mode.

**2 Press [◀, ▶] to select “Hour” and “Min.” and press [▲, ▼] to set the recording time.**

- You can also set the recording time with the numbered buttons.
- You cannot record for more than 8 hours.

**3 When you want to start recording**

Press [▲, ▼, ▶, ▶] to select “Start” and press [ENTER].

- Recording starts.
- All the recording modes from XP to EP appear in the display.

**To exit the screen without recording**

Press [RETURN].

**To stop recording partway**

Press [■].

**To show the remaining time**

Press [STATUS].

e.g., HDD



Remaining time

**Playing while you are recording**

**HDD RAM**

**Playing from the beginning of the title you are recording—Chasing playback****Press [▶] (PLAY) during recording.**

- There is no sound output while searching forward or backward.

**To stop play**

Press [■].

**To stop recording**

2 seconds after play stops

Press [■].

**To stop scheduled recording**

Press [■], then [ENTER] within 5 seconds.

- You can also press and hold [■] on the main unit for more than 3 seconds to stop recording.

**Playing a title previously recorded while recording—Simultaneous rec and play**

- You can also change the drive and play while recording. Press [HDD] or [DVD].

**1 Press [DIRECT NAVIGATOR] during recording.****2 Press [▲, ▼, ▶, ▶] to select a title and press [ENTER].**

- There is no sound output while searching forward or backward.

**To stop play**

Press [■].

**To exit the Direct Navigator screen**

Press [DIRECT NAVIGATOR].

**To stop recording**

After play stops

- 1 Press [DIRECT NAVIGATOR] to exit screen.
- 2 If the recording is on the other drive Press [HDD] or [DVD] to select the recording drive.
- 3 Press [■].

**To stop scheduled recording**

Press [■], then [ENTER] within 5 seconds.

- You can also press and hold [■] on the main unit for more than 3 seconds to stop recording.

**Reviewing the recorded images while recording—Time Slip**

While recording, you can play a scene in the title being recorded or a previously recorded title. Both images being played and recorded are shown.

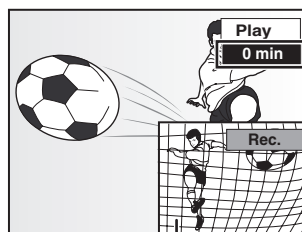
**1 Press [TIME SLIP] during recording.**

This automatically disappears after approximately 5 seconds. To show the screen again press [TIME SLIP] again.

The image currently being recorded

- Play starts from 30 seconds previous.
- You will hear the playback audio.

**2 Press [▲, ▼] to select the time and press [ENTER].**

- Each time you press [▲, ▼], the time increases [▲] or decreases [▼] by 1 minute. (Press and hold for 10-minute intervals.)
- Press [▶] (PLAY) to show the play images in full. Press [TIME SLIP] to show the play and recording images.

**To stop play**

Press [■].

**To stop recording**

2 seconds after play stops

Press [■].

**To stop scheduled recording**

Press [■], then [ENTER] within 5 seconds.

- You can also press and hold [■] on the main unit for more than 3 seconds to stop recording.

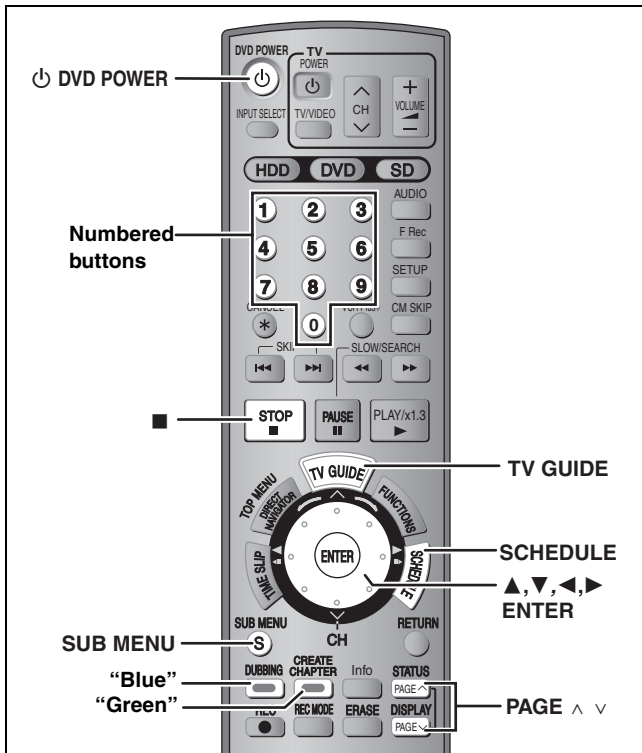

**HDD** **RAM** **-R** **-RW(V)** **+R**

### For successful scheduled recordings

The program list will not display immediately after purchasing this unit. Complete the TV Guide On Screen™ system setup and download the program list data (➔ 16).

- **-R** **-RW(V)** **+R** When recording MTS broadcasts, select the audio recording type in “Select MTS” (➔ 56).
- **HDD** If you set “Rec. for High-Speed Dubbing” to “On” before recording to the HDD, you can later high speed transfer (dub) the program to DVD-R, DVD-RW (DVD-Video format) and +R.

### Preparation

- Turn on the television and select the appropriate video input to suit the connections to this unit.
- If recording to DVD, insert a disc that you can use for recording (➔ 20).

## Using the TV Guide On Screen™ system to make scheduled recordings

You can perform scheduled recording easily by just marking the desired program(s) in a television program list.

- You can enter up to 8 days in advance.
- The program name becomes the recorded title if the program is listed on the television program list.

## 1 Press [TV GUIDE].

Further instructions on utilizing the TV Guide On Screen™ system ➔ 28

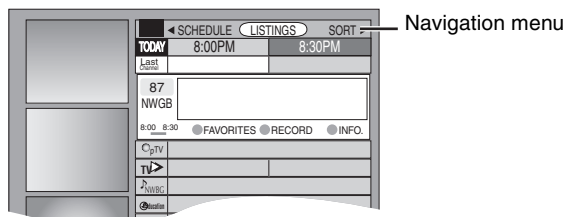

## 2 Press [▲, ▼, ◀, ▶] to select the program.

- To skip one screen  
Press [PAGE ▲] or [PAGE ▼].
- To skip 24 hours in the list  
Press [▲, ▼, ◀, ▶] to select “LISTINGS” and  
– Press the “Green” button (forward).  
– Press the “Blue” button (backward).

## 3 Press the “Green” button.

“R” appears in the list to indicate that the program is set for scheduled recording.

- Press the “Green” button to cancel.
- Press the “Blue” button to change recording frequency.

Each time you press the button:

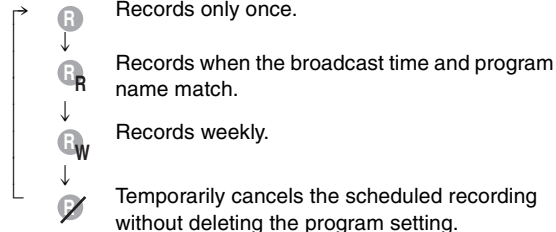

Repeat steps 2–3 to program other recordings.

- As long as the setting is not changed, the program is recorded to the HDD in the recording mode selected by the unit. To change the setting ➔ below.

### ■ To change the setting

- 1 Press [SUB MENU] to go to the Navigation menu.
- 2 Press [◀, ▶] to select “SCHEDULE”.
- 3 Press [▲, ▼] to select the program and press [ENTER].

Start early by : 00 minutes  
End late by : 00 minutes  
Quality : SP  
Destination : HDD

## 4 Change the setting as necessary and press [ENTER].

### • To set recording to start early or end late

Press [▲, ▼] to select “Start early by” or “End late by” and press the numbered buttons to enter minutes (up to 99).

### • To change the recording mode

Press [▲, ▼] to select “Quality” and press the “Blue” button.

Each time you press the button:

LP → EP → FR → XP → SP

### • To change the recording drive

Press [▲, ▼] to select “Destination” and press the “Blue” button.

Each time you press the button:

HDD ↔ DVD

When the recording drive is “DVD” and there is not enough remaining space, recording automatically switches to the “HDD” (➔ 27, Relief Recording).

## 4 Press [TV GUIDE].

Returns to the television screen.

- The unit goes to scheduled recording standby (“Ⓞ” lights on the unit’s display); however, it may not turn off automatically. To save power, turn the unit off by pressing [DVD POWER].
- Scheduled recordings are activated regardless of whether the unit is turned on/off.
- When using the cable TV box, make sure the cable TV box is turned on.

### ■ Notes on scheduled recording ➔ 27

### ■ To check, change or delete a program ➔ 27



■ **To cancel recording when it has already begun**

Press [■], then [ENTER] within 5 seconds.

- You can also press and hold [■] on the main unit for more than 3 seconds to stop recording.
- There may be some channels that are not displayed in the television program list even if they are receivable. In this case set them manually (⇒below).

## Manually programming scheduled recordings

- You can manually set the date, channel, start and end times and so on for programs you want to record.

### 1 Press [SCHEDULE].

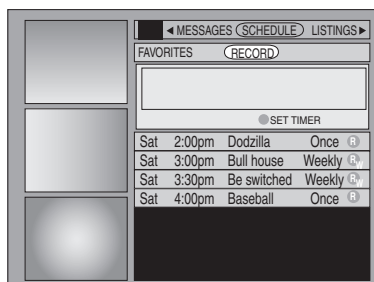

### 2 Press the “Green” button.

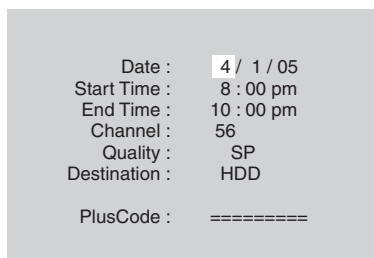

### 3 Enter the settings.

- **To enter the date**  
Press [▲, ▼] to select “Date” and press the numbered buttons.  
(Date: Month/Day/Year)
- **To enter the time**  
Press [▲, ▼] to select “Start Time” or “End Time” and press the numbered buttons.  
–You can set up to 8 hours.  
–To change am/pm  
Press [◀, ▶] to select “am” or “pm” and press the “Blue” button.
- **To enter the channel**  
Press [▲, ▼] to select “Channel” and press the numbered buttons.  
–To select the input channel (IN1/IN2/IN3/DV)  
Press the “Blue” button.
- **To change the recording mode**  
Press [▲, ▼] to select “Quality” and press the “Blue” button.  
Each time you press the button:  
LP → EP → FR → XP → SP

- **To change the recording drive**

Press [▲, ▼] to select “Destination” and press the “Blue” button.

Each time you press the button:  
HDD ↔ DVD

When the recording drive is “DVD” and there is not enough remaining space, recording automatically switches to the “HDD” (⇒ 27, Relief Recording).

### 4 Press [ENTER].

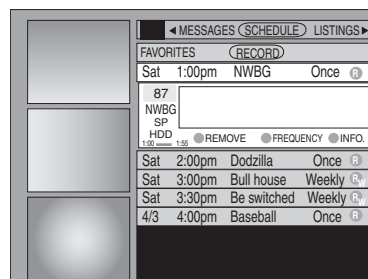

- Press the “Green” button to change recording frequency.

Each time you press the button:

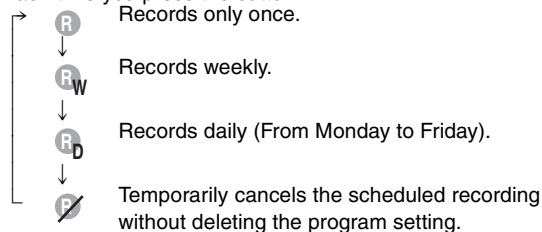

- **To program other recordings**

Press [▲, ▼, ◀, ▶] to select “RECORD” and repeat steps 2–4.

### 5 Press [TV GUIDE].

Returns to the television screen.

- The unit goes to scheduled recording standby (“Ⓢ” lights on the unit’s display); however, it may not turn off automatically. To save power, turn the unit off by pressing [⏻ DVD POWER].
- Scheduled recordings are activated regardless of whether the unit is turned on/off.
- When using the cable TV box, make sure the cable TV box is turned on.

### ■ Notes on scheduled recording ⇒ 27

### ■ To check, change or delete a program ⇒ 27

### ■ To cancel recording when it has already begun

Press [■], then [ENTER] within 5 seconds.

- You can also press and hold [■] on the main unit for more than 3 seconds to stop recording.

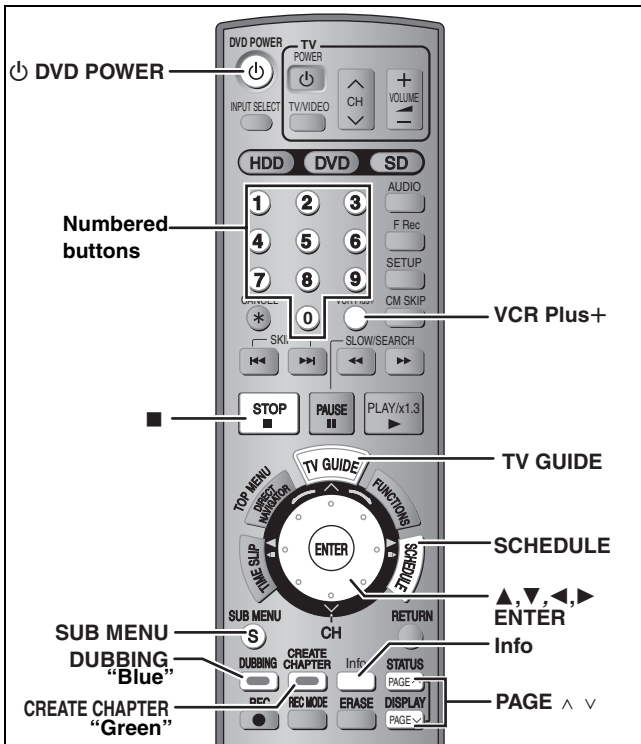

**HDD RAM -R -RW(V) +R**  
**Using VCR Plus+ system to make scheduled recordings**

**Preparation**

Entering PlusCode® numbers is an easy way of scheduling recording. You can find them in TV listings in newspapers and magazines.

- You can enter up to 8 days in advance.
- VCR Plus+ system works only after this unit downloads the television program list (➔ 16).

**1 Press [VCR Plus+].**

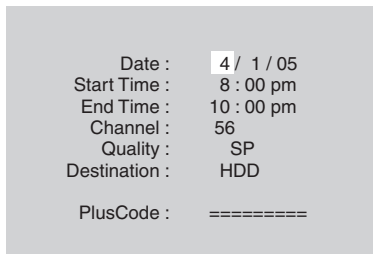

**2 Press [▲, ▼] to select “PlusCode”.**

**3 Press the numbered buttons to enter the PlusCode number.**

- **To correct the number**  
 Press [▲] and press [▼]. Enter the number again from the beginning.

**4 Press [ENTER].**

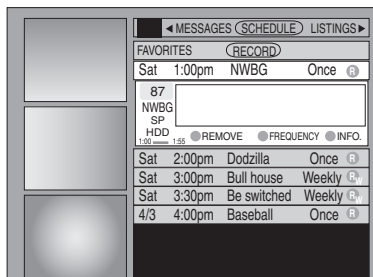

Repeat steps 1–4 to program other recordings.

- As long as the setting is not changed, the program is recorded to the HDD in the recording mode selected by the unit. To change the setting ➔ 24, “To change the setting” steps ③–④.

**5 Press [TV GUIDE].**

Returns to the television screen.

- The unit goes to scheduled recording standby (“⊖” lights on the unit’s display); however, it may not turn off automatically. To save power, turn the unit off by pressing [DVD POWER].
- Scheduled recordings are activated regardless of whether the unit is turned on/off.
- When using the cable TV box, make sure the cable TV box is turned on.

**■ Notes on scheduled recording ➔ 27**

**■ To check, change or delete a program ➔ 27**

**■ To cancel recording when it has already begun**  
 Press [■], then [ENTER] within 5 seconds.

- You can also press and hold [■] on the main unit for more than 3 seconds to stop recording.

## Check, change or delete a program

You can check, change or delete a program set for scheduled recording on the television screen.

### 1 Press [SCHEDULE].

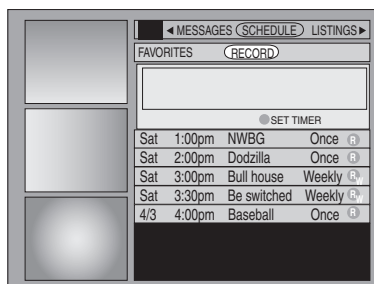

### 2 Press [▲, ▼] to select the program.

Channel or program name (a program name that was set for scheduled recording using TV Guide On Screen™ system or VCR Plus+ system that was listed in the program list)

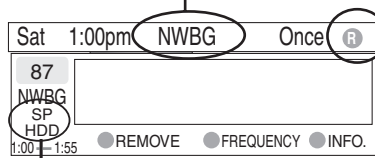

Recording mode (→ 21)  
Recording drive

Frequency (→ 24, Step 3,  
→ 25, Step 4)

#### ■ To change the recording frequency

Press the "Green" button.

#### ■ To change the time, recording mode and recording drive

Press [ENTER]. (→ 24, To change the setting, step ④)

#### ■ To delete the program

Press the "Blue" button.

#### ■ To exit the screen

Press [TV GUIDE].

Returns to the television screen.

- The unit is not off. To save power, turn the unit off by pressing [DVD POWER].

#### ■ When there is a duplicate or overlapping program scheduled recording

The program scheduled recording that was set last is recorded. None of the program that was set earlier is recorded even if there is only partial overlapping. Program scheduled recordings that are not recorded are highlighted in grey.

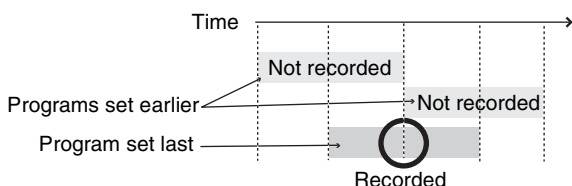

## Notes on scheduled recording

- "Ⓞ" flashes when the unit cannot go to scheduled recording standby.
- Scheduled recordings are activated regardless of whether the unit is turned on/off.
- Scheduled recordings do not begin while transferring (dubbing) in normal speed mode (→ 43).
- If the unit is turned on when scheduled recording begins, it remains turned on after recording finishes. It does not turn off automatically. You can turn the unit off during scheduled recording.
- When you program successive scheduled recordings to start immediately one after the other, the unit cannot record the part at the ending of the earlier program (approximately 15 seconds). In addition, when recording to DVD-R, DVD-RW (DVD-Video format) or +R, the unit cannot record the part at the beginning of the later program (approximately 15 seconds).

e.g., When you program successive one hour scheduled recordings to start at 10:00 and 11:00

Program① 10:00–11:00

Program② 11:00–12:00

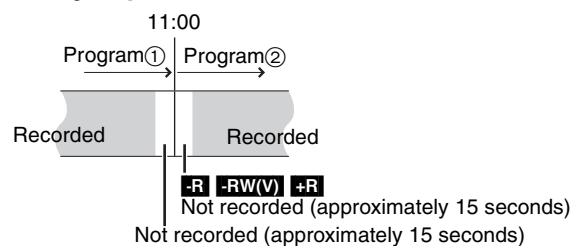

- If you set DST (Daylight Saving Time) to ON when manually setting the clock (→ 17), scheduled recording may not work when summer switches to winter and vice versa.

#### ■ Relief Recording

When the recording drive is set to "DVD" for scheduled recording and if the program will not fit onto the disc, the recording drive will be changed to the "HDD" automatically. If there is no disc in the tray or the disc cannot be recorded on or when scheduled recording starts while transferring (dubbing), the recording drive will be changed to the HDD.

- The Direct Navigator shows which programs were relief-recorded ("↔" is displayed.) (→ 30).
- If the time remaining on the HDD is insufficient, as much of the program as possible will be recorded onto the HDD.

Refer to the control reference on page 26.

## 1 Press [TV GUIDE].

Video window (The channel you were previously watching is displayed.)

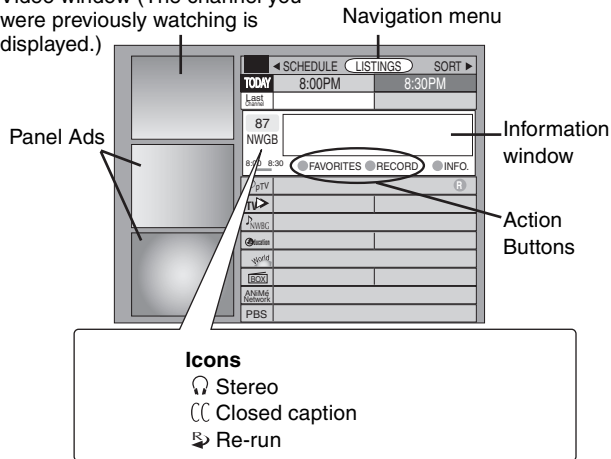

Programs are categorized by color.

- Green: Sports
- Blue: Children's
- Purple: Movies
- Teal: Other categories

### ■ To change to the selected channel

Press [ENTER].

While recording, you cannot change from the channel being recorded.

## 2 Press [SUB MENU] to go to the Navigation menu.

## 3 Press [◀, ▶] to select the item and press [▼].

One of the following screens will appear depending on the item selected.

- LISTINGS
- SORT
- PROMOTIONS
- SCHEDULE
- MESSAGES
- SETUP

### Common operations

[▲, ▼, ◀, ▶] [ENTER]	Select/Enter
[PAGE ▲][PAGE ▼]	Skip one screen
[SUB MENU]	Move to the Navigation menu
[CREATE CHAPTER] (Green)	"Green" Action Button The Action Button functions will be displayed on the screen.
[DUBBING] (Blue)	"Blue" Action Button The Action Button functions will be displayed on the screen.
[Info]	Change the size of information window

### LISTINGS screen

The LISTINGS screen displays the station, title, time, length, contents and ratings. It allows you to scroll through current and future program listings and register them for recording or as a "Favorite", and jump directly to the program channel through a one-touch button.

### Functions of Action Buttons

+24 HRS:	Skip 24 hours forward
-24 HRS:	Skip 24 hours backward
LOCK:	Lock the program currently selected in the Video Window
UNLOCK:	The Video Window display will change as different programs are highlighted
RECORD:	Record this program (⇒ 24, Step 3)
FAVORITES:	Register this program as a "Favorite" (⇒ right)
CANCEL REC./ CANCEL FAV.:	Cancel recording or a "Favorite"
FREQUENCY:	Change the frequency of recording or a "Favorite"

### ■ Registering a program you don't want to miss as a "Favorite"

By registering a program as a "Favorite", you can later tune to that program quickly by pressing the "Blue" button when that program begins broadcasting.

When watching TV, we recommend you occasionally press the "Blue" button. This unit may tune into a "Favorite" program that you had forgotten about.

### To register a program as a "Favorite"

Press the "Blue" button on the program.

"♥" appears in the list to indicate that the program is set as a "Favorite".

- Press the "Green" button to change the frequency.

Each time you press the button:

- ↓ Registers as a "Favorite" only once.
- ↓ A program becomes a "Favorite" when the broadcast time and program name match.
- ↓ Registers as a "Favorite" weekly.
- ↓ "Favorite" registration temporarily off.

- Press the "Blue" button to cancel.

Repeat the above to set other programs.

- When there is more than one program registered as "Favorite" in the same time frame, each time you press the "Blue" button, the program switches to the other.

### SORT screen

The SORT screen displays program listings sorted into your preferred categories. You can register programs on the list for recording or as a "Favorite", and jump directly to the program channel through a one-touch button.

There are various categories, such as movies, sports, children's, educational, news, variety, series, HDTV, and alphabetically. Each category will contain individual sub-categories.

- 1 Press [◀, ▶] to select the major category and press [▼].
- 2 Press [▲, ▼, ◀, ▶] to select the minor category and press [ENTER].
- 3 Press [▲, ▼, ◀, ▶] to select a program.
  - When sorting alphabetically, programs with the same name (such as reruns or subsequent broadcasts of the same program) are displayed together in one column. In this case, press [▲, ▼] to select a program name and press [ENTER]. Each broadcast of the program is then displayed separately. Press [▲, ▼] to select the desired program.

### Functions of Action Buttons

RECORD:	Record this program (⇒ 24, Step 3)
FAVORITES:	Register this program as a "Favorite" (⇒ above)
CANCEL REC./ CANCEL FAV.:	Cancel recording or a "Favorite"
FREQUENCY:	Change the frequency of recording or a "Favorite"

### SCHEDULE screen

The SCHEDULE screen displays programs registered for recording or as a "Favorite" separately on the list. In addition to being able to review the list, you can also remove programs and change the frequency or modify the start/end times (only when recording) of programs selected.

### Functions of Action Buttons

SET TIMER:	Show the manual scheduled recording screen (⇒ 25, Step 2)
CANCEL:	Cancel an entry on the manual scheduled recording screen
FREQUENCY:	Change the frequency of recording or a "Favorite"
REMOVE/STOP	Remove the scheduled recording or "Favorite" program/Stop scheduled recording

## SETUP screen

The SETUP screen allows you to redo the channel settings, customize the channel line-up and set the TV Guide On Screen™ system's start-up pattern.

### ■ “Change system settings” menu—Access to the TV Guide On Screen™ system setup screen

You can also verify any information entered during setup, or completely redo the setup, for the TV Guide On Screen™ system.

- Press [▲, ▼] to select “Change system settings” and press [ENTER].  
The information that was set is displayed, and you are asked to confirm whether it is correct.

Postal code - L4W 2T3 (Canada)
Cable - Yes
Cable box - No
Are the above settings correct?
<b>Yes, everything is correct</b>
Yes, but my channel lineup is incorrect
No, repeat setup process

- Press [▲, ▼] to select the message and press [ENTER].
  - “Yes, everything is correct”
    - The information that was set will remain intact. Press [ENTER] again to exit the screen.
  - “Yes, but my channel lineup is incorrect”
    - You can customize the channel line-up in the CHANNEL EDITOR screen (⇒ below). Press [▲, ▼] to select “No Match” and press [ENTER].
  - “No, repeat setup process”
    - The TV Guide On Screen™ system setup screen is displayed. Follow the on-screen prompts to redo the setup (⇒ 16, step 2).

### ■ “Change channel display” menu—CHANNEL EDITOR

The “Change channel display” menu allows you to customize the channel line-up using the CHANNEL EDITOR. You can easily change channel line-up should the cable company occasionally revise their channel assignments.

- Press [▲, ▼] to select “Change channel display” and press [ENTER].
- Press [▲, ▼] to select the channel.
  - Press [PAGE ▲] or [PAGE ▼] to skip one screen.
- Customize the channel as follows.

#### To display/hide the channel

Press the “Green” button to select “ON” (display) or “OFF” (hide).

<input type="radio"/> PTV	PTV-S	2	ON
● CANCEL ● ON/OFF ● INFO.			
<input checked="" type="radio"/> TV	TV-TR	5	ON
<input checked="" type="radio"/> NWBG	NWBG	12	ON
<input checked="" type="radio"/> Education	EDU	22	ON

CHANNEL EDITOR screen

#### To change the channel number

Press the numbered buttons.

e.g. 1: [0] ⇒ [0] ⇒ [1]  
 15: [0] ⇒ [1] ⇒ [5]  
 115: [1] ⇒ [1] ⇒ [5]

#### To change the order of the channels

- Press [◀].
- Press the “Blue” button to move up or the “Green” button to move down.

<input type="radio"/> PTV	PTV-S	2	ON
● MOVE UP ● MOVE DOWN ● INFO.			
<input checked="" type="radio"/> TV	TV-TR	5	ON
<input checked="" type="radio"/> NWBG	NWBG	12	ON
<input checked="" type="radio"/> Education	EDU	22	ON

Repeat steps 2–3 as necessary.

- Press [TV GUIDE].

### ■ “Review options” menu—Selecting the TV Guide On Screen™ system start up pattern

- Press [▲, ▼] to select “Review options” and press [ENTER].
- Press [▲, ▼] to select the option and press [ENTER].
  - On: Turns on auto start up.
  - Off: Turns off auto start up.

## MESSAGES screen

The MESSAGES screen is where additional product program or other information can be received and displayed by the TV Guide On Screen™ system. If major changes to the program listings are scheduled to be made, they will be displayed in the message section. The serial number specific to your TV Guide On Screen™ system can also be found on this screen.

When there are unread messages, an envelope-shaped icon appears at the upper left of the screen. 

#### To read a message

Press [▲, ▼] to select the message and press [Info].

- To delete unwanted messages press the “Green” button.
- Messages are automatically deleted after 60 days.

## PROMOTIONS screen

The PROMOTIONS screen provides you with a list of promotional items that have appeared as Panel Ads or Channel banners during the current day. Promotions are updated daily during pre-designated download times.

#### To read a promotion

Press [▲, ▼] to select the item and press [Info].

#### Functions of Action Buttons

(When the TV program item is highlighted)

RECORD:	Record this program (⇒ 24, Step 3)
FAVORITES:	Register this program as a “Favorite” (⇒ 28)

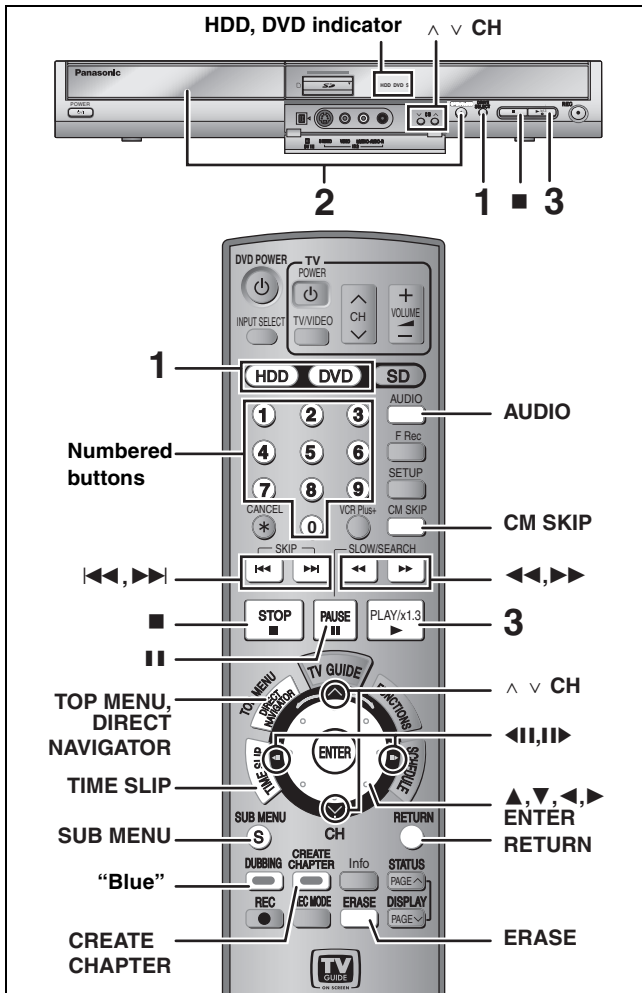

### Preparation

- Turn on the television and select the appropriate video input to suit the connections to this unit.
- Turn on this unit.
- Press [RETURN] to exit the television program list if it is displayed on the television. To turn off auto start up of the television program list → 29, "Review options" menu

## 1 Press [HDD] or [DVD] to select the playback drive.

The HDD or DVD indicator lights up on the unit.

- It is possible to watch playback from one drive while recording on another (editing is not possible).

## 2 If you selected the DVD drive

### Press [▲ OPEN/CLOSE] on the main unit to open the tray and insert a disc.

- Press the button again to close the tray.
- When using 8 cm (3") DVD-RAM or 8 cm (3") DVD-R, remove the disc from the cartridge.

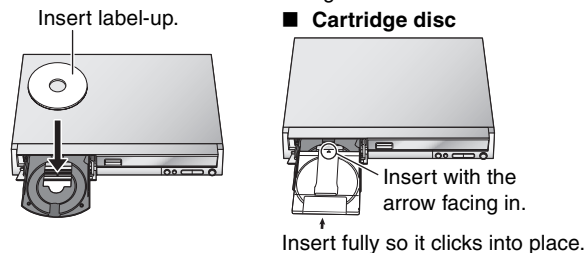

## 3 Press [▶] (PLAY).

**HDD RAM -R -RW(V) +R -RW(VR)**

Play starts from the most recently recorded title.

**DVD-V DVD-A CD VCD**

Play starts from the beginning of the disc.



- When using cartridge discs with the write-protect tab in the protect position (→ 50), play automatically starts when inserted in the unit.

## ■ Selecting recorded programs (titles) to play—Direct Navigator

**HDD RAM -R -RW(V) +R -RW(VR)**

### 1 Press [DIRECT NAVIGATOR].

#### •Thumbnail Mode

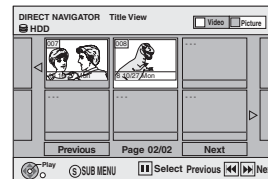

#### •Table Mode

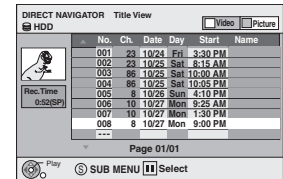

### Switching the Direct Navigator appearance

- 1 Press [SUB MENU] while Thumbnail Mode is displayed.
  - 2 Press [▲, ▼] to select "Table Mode" and press [ENTER].
- The display appearance last used is saved even after the unit is turned off.

### 2 **HDD RAM** Press the "Blue" button to select "Video".



### **HDD** To sort Title View for easy searching (Table Mode only)

This function is convenient when searching for one title to playback from many titles.

- 1 Press [SUB MENU].
- 2 Press [▲, ▼] to select "Sort" and press [ENTER].
- 3 Press [▲, ▼] to select the item and press [ENTER].

If you select an item other than "No."

- The Direct Navigator screen will reappear after playback of the selected title has finished. (You cannot play titles continuously.)
- Skip and Time Slip will only function with the title currently being played back.
- If you exit the Direct Navigator screen, or switch to the "Picture" Direct Navigator screen, the sorted Title View will be cancelled.

### 3 Press [▲, ▼, ◀, ▶] to select the title and press [ENTER].

You can also select titles with the numbered buttons.

**HDD** e.g., 5: [0] → [0] → [5]      **RAM -R -RW(V) +R -RW(VR)** 5: [0] → [5]  
 15: [0] → [1] → [5]      15: [1] → [5]  
 115: [1] → [1] → [5]

### To show other pages

Press [▲, ▼, ◀, ▶] to select "Previous" or "Next" and press [ENTER]. (Thumbnail Display only)

- You can also press [◀◀, ▶▶] to show other pages.

### To exit the screen

Press [DIRECT NAVIGATOR].

### Direct Navigator screen icons

- 🔒 Title protected.
- 📄 Title that was not recorded due to recording protection (Digital broadcasts, etc.)
- ✗ Title cannot be played [When transferring (dubbing) a title to the HDD, or when data is damaged, etc.]
- Currently recording.
- ➡ Titles that have been rerouted to the HDD (→ 27, Relief Recording)
- 📄 Title with "One time only recording" restriction (→ 68, CPRM)

## ■ When a menu screen appears on the television

**DVD-V DVD-A**

Press [▲, ▼, ◀, ▶] to select the item and press [ENTER].

Some items can also be selected using the numbered buttons.

**VCD**

Press the numbered buttons to select the item.

e.g., 5: [0] ⇒ [5] 15: [1] ⇒ [5]

### ● To return to the menu screen

**DVD-V** Press [TOP MENU] or [SUB MENU].



**DVD-A** Press [TOP MENU].

**VCD** Press [RETURN].

### Note

- It is not possible to play continuously from one side of a double sided disc to the other. You will need to eject the disc and turn it over.
- Depending on the disc, it may take time for the menu screen, pictures, sound, etc. to start.
- Discs continue to rotate while menus are displayed. Press [■] when you have finished playback to protect the unit's motor, your television screen and so on.

## Operations during play

<p>Stop</p>	<p><b>Press [■].</b> The stopped position is memorized. “PLAY” flashes in the unit's display. (Excluding when playing from the Direct Navigator and when playing a playlist.)</p> <p><b>Resume play function</b> Press [▶] (PLAY) to restart from this position. Stopped position</p> <ul style="list-style-type: none"> <li>● If [■] is pressed several times, “PLAY” disappears and the position is cleared.</li> <li>● The position is cleared if the unit is turned off or the tray is opened.</li> </ul>	
<p>Pause</p>	<p><b>Press [II].</b> Press [II] again or [▶] (PLAY) to restart play.</p>	
<p>Search</p>	<p><b>Press [◀◀] or [▶▶].</b> The speed increases up to 5 steps.</p> <ul style="list-style-type: none"> <li>● You can also turn the Smart Wheel left or right for operation (excluding <b>CD VCD</b>).</li> <li>● Press [▶] (PLAY) to restart play.</li> <li>● Audio is heard during first level search forward.</li> </ul> <p><b>DVD-A</b> (excluding moving picture parts) <b>CD</b> Audio is heard during all levels of search.</p> <ul style="list-style-type: none"> <li>● Depending on the disc, search may not be possible.</li> </ul>	
<p>Skip</p>	<p><b>During play or while paused, press [◀◀] or [▶▶].</b> Skip to the title, chapter or track you want to play.</p> <ul style="list-style-type: none"> <li>● Each press increases the number of skips.</li> </ul>	
<p>Starting from a selected item</p>	<p><b>Press the numbered buttons.</b> Play starts from the selected title, chapter or track.</p> <p><b>HDD CD</b> (discs with MP3 files and JPEG/TIFF) e.g., 5: [0] ⇒ [0] ⇒ [5] 15: [0] ⇒ [1] ⇒ [5]</p> <p><b>DVD-A</b> Selecting groups While stopped (screen saver is displayed on the television ⇒ right) e.g., 5: [5]</p> <p>Other discs (You can select a track with DVD Audio.) e.g., 5: [0] ⇒ [5] 15: [1] ⇒ [5]</p> <ul style="list-style-type: none"> <li>● This works only when stopped (screen saver is displayed on the television ⇒ above) with some discs.</li> <li>● <b>VCD</b> (with playback control) If you press the numbered buttons while stopped (the above screen saver is displayed on the television) you can cancel PBC. (Elapsed play time appears on the unit's display.)</li> </ul>	
<p>Quick View <b>HDD RAM</b></p>	<p><b>Press and hold [▶] (PLAY/× 1.3).</b> Play speed is quicker than normal.</p> <ul style="list-style-type: none"> <li>● Press again to return to normal speed.</li> </ul>	
<p>Slow-motion <b>HDD RAM -R -RW(V) +R DVD-V DVD-A</b> (Motion picture parts only) <b>-RW(VR) VCD</b></p>	<p><b>While paused, press [◀◀] or [▶▶].</b> The speed increases up to 5 steps.</p> <ul style="list-style-type: none"> <li>● You can also turn the Smart Wheel left or right for operation (excluding <b>VCD</b>).</li> <li>● Press [▶] (PLAY) to restart play.</li> <li>● <b>VCD</b> Forward direction [▶▶] only.</li> <li>● The unit will pause if slow-motion play is continued for approximately 5 minutes (excluding <b>DVD-V DVD-A VCD</b>).</li> </ul>	
<p>Frame-by-frame <b>HDD RAM -R -RW(V) +R DVD-V DVD-A</b> (Motion picture parts only) <b>-RW(VR) VCD</b></p>	<p><b>While paused, press [◀] (◀II) or [▶] (II▶).</b> Each press shows the next frame.</p> <ul style="list-style-type: none"> <li>● Press and hold to change in succession forward or backward.</li> <li>● Press [▶] (PLAY) to restart play.</li> <li>● <b>VCD</b> Forward direction [▶] (II▶) only.</li> </ul>	

Refer to the control reference on page 30.

### Displaying the television image as a picture-in-picture

HDD RAM -R -RW(V) +R  
-RW(VR)

#### Press [TIME SLIP].

The unit displays the television image as a picture-in-picture.

- You will hear the playback audio.
- Press [▶] (PLAY) to cancel.
- The blue background does not appear on the receiving screen even if you select "On" in "Blue Background" in the SETUP menu (⇒ 56).

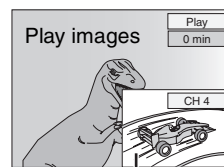

Current receiving images

- You can change the channel being received by pressing [^ v CH]. (You cannot change the channel being received while recording.)

### Skipping the specified time (Time Slip)

HDD RAM -R -RW(V) +R  
-RW(VR)

- 1 Press [TIME SLIP].
- 2 Press [▲, ▼] to select the time and press [ENTER].

Play skips the specified time.

- Each time you press [▲, ▼], the time increases [▲] or decreases [▼] by 1 minute intervals. (Press and hold for 10-minute intervals.)
- Press [▶] (PLAY) to show the play images in full.

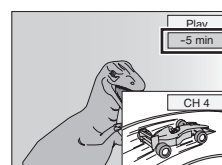

This automatically disappears after approximately 5 seconds. To show the screen again Press [TIME SLIP] again.

### CM Skip

HDD RAM -R -RW(V) +R  
-RW(VR)

#### Press [CM SKIP].

Each time you press, play restarts approximately a minute later.

Playing back

## Simple editing operations during play

### Erase

HDD RAM -R -RW(V) +R

- 1 Press [ERASE].
- 2 Press [◀, ▶] to select "Erase" and press [ENTER].

- A title cannot be restored once it is erased. Make certain before proceeding.
- You cannot erase while recording or transferring (dubbing).
- [-R +R] Available space does not increase after erasing.
- [-RW(V)] Disc space increases only when the last recorded title is erased.

### Create chapters

(⇒ 38, Title/Chapter)

HDD RAM

#### Press [CREATE CHAPTER].

Chapters are divided at the point pressed.

- Press [◀◀, ▶▶] to skip to the start of a chapter.

## Changing audio during play

### Press [AUDIO].

HDD RAM -RW(VR) VCD

Stereo → Mono L → Mono R

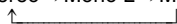

e.g., "Stereo" is selected



DVD-V DVD-A

You can change the audio channel number each time you press the button. This allows you to change things like the soundtrack language (⇒ 36, Soundtrack).



e.g., English is selected.



# Using menus to play MP3

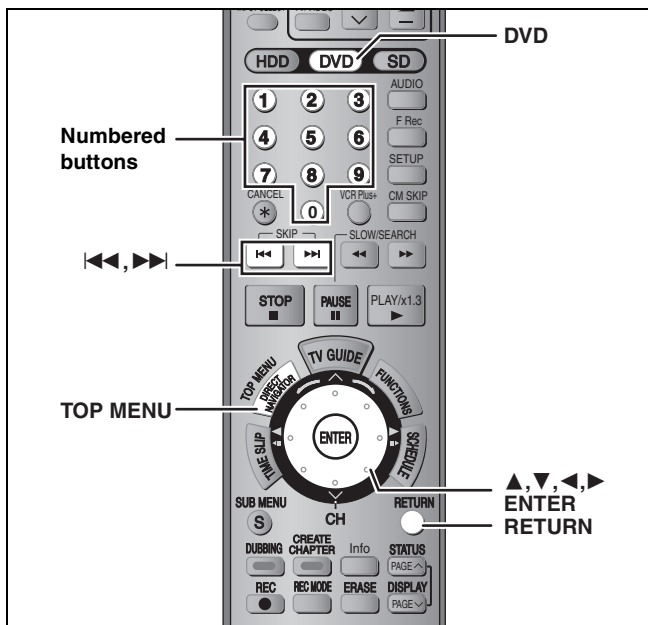

CD

## Preparation

Press [DVD] to select the DVD drive.

This unit plays MP3 files recorded on CD-R/RW designed for audio recording that are finalized (⇒ 68) on a computer. The screen shown below is displayed when you insert a disc containing MP3 files and still pictures (JPEG/TIFF).

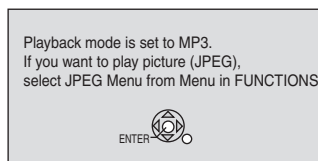

Press [ENTER], and follow the steps below.

## 1 Press [TOP MENU].

G: Group No.  
T: Track No. in the group  
Total: Track No./Total tracks in all groups

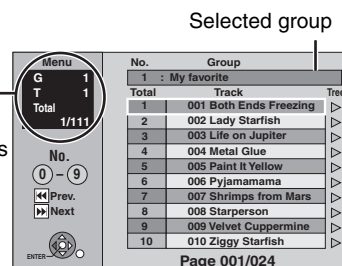

- Files are treated as tracks and folders are treated as groups.
- When the JPEG Menu is displayed, perform steps 1–4 in “To select JPEG Menu” on page 34 selecting “MP3 Menu” in step 4 to change to the MP3 Menu.

## 2 Press [▲, ▼] to select the track and press [ENTER].

Play starts on the selected track.

- “” indicates the track currently playing.
- You can also select the track with the numbered buttons.  
e.g., 5: [0] ⇒ [0] ⇒ [5]  
15: [0] ⇒ [1] ⇒ [5]

### To show other pages

Press [◀, ▶].

### To exit the screen

Press [TOP MENU].

## Using the tree screen to find a group

- While the file list is displayed Press [▶] while a track is highlighted to display the tree screen.

Selected group No. /Total groups

If the group has no track, “- -” is displayed as group number.

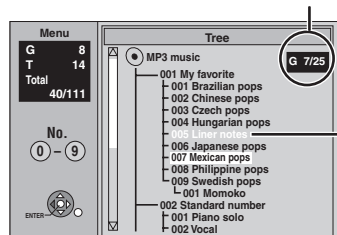

You cannot select groups that contain no compatible files.

## 2 Press [▲, ▼, ◀, ▶] to select a group and press [ENTER].

The file list for the group appears.

### Regarding MP3

- Compatible formats: ISO9660 level 1 or 2 (except for extended formats), Joliet
- Maximum number of files (tracks) and folders (groups) recognizable: 999 files (tracks) and 99 folders (groups)
- This unit is compatible with multi-session but reading or play of the disc may take time if there are a lot of sessions.
- Operation may take time to complete when there are many files (tracks) and/or folders (groups) and some files (tracks) may not display or be playable.
- The display order on this unit may differ from how the order is displayed on a computer.
- Depending on how you create the disc (writing software), files (tracks) and folders (groups) may not play in the order you numbered them.
- This unit is not compatible with packet-write format.
- File format: MP3  
Files must have the extension “.mp3” or “.MP3”.
- Bit rates: 32 kbps to 320 kbps
- Sampling frequency: 16 kHz/22.05 kHz/24 kHz/32 kHz/44.1 kHz/48 kHz
- This unit is not compatible with ID3 tags.
- If there is a large amount of still picture data etc. within a MP3 file, play may not be possible.

### Structure of MP3 folders

Prefix with 3-digit numbers in the order you want to play them.

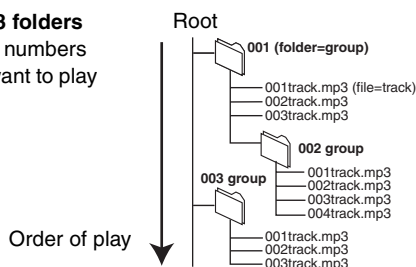

### To return to the file list

Press [RETURN].

Playing back

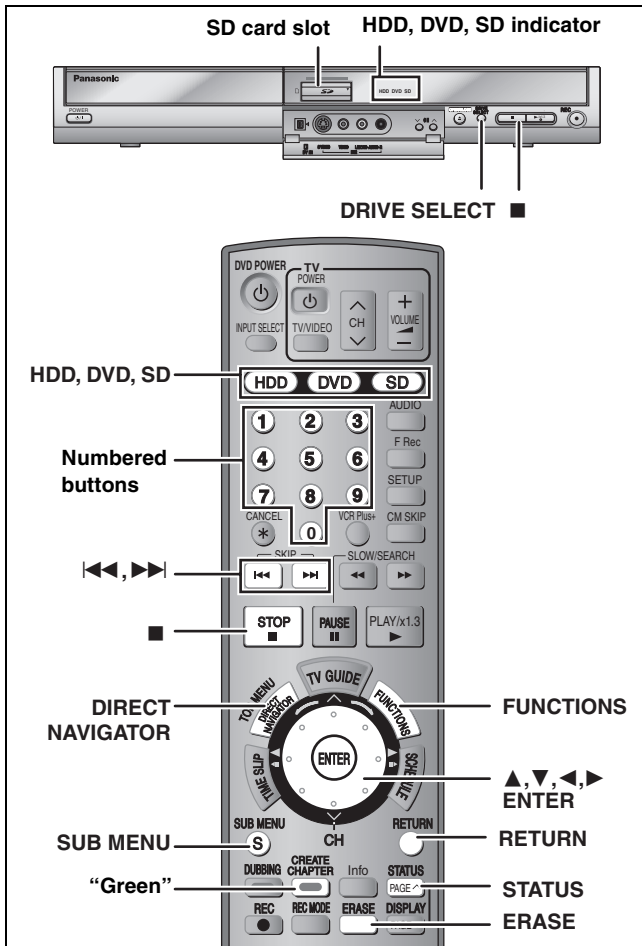

**HDD RAM SD CD**

• You can use SD Memory Cards with capacities from 8 MB to 1 GB (⇒ 9).

## 1 Press [HDD], [DVD] or [SD] to select the drive.

The indicator lights up on the unit.

• On the main unit, press [DRIVE SELECT] several times.

**CD**

The screen shown below is displayed when you insert a disc containing MP3 files and still pictures (JPEG/TIFF). Select JPEG menu (⇒ right, "To select JPEG Menu") before performing the steps below.

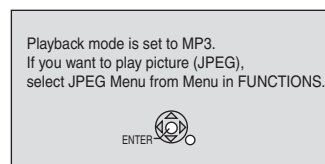

## 2 Press [DIRECT NAVIGATOR].

**HDD RAM**

Press the "Green" button to select "Picture".

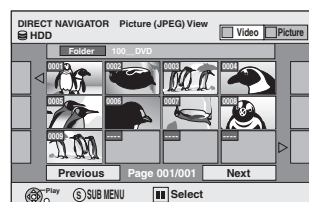

Picture (JPEG) View screen

Direct Navigator screen icons

- Picture protected.
- Picture in which the number of prints is set (DPOF) (⇒ 42, 68).

### To show other pages

Press [▲, ▼, ◀, ▶] to select "Previous" or "Next" and press [ENTER].

• You can also press [◀◀, ▶▶] to show other pages.

To select the still pictures in another folder ⇒ 35

## 4 Press [▲, ▼, ◀, ▶] to select the still picture and press [ENTER].

You can also select still pictures with the numbered buttons.

e.g., **HDD RAM SD**

5: [0] ⇒ [0] ⇒ [0] ⇒ [5]      115: [0] ⇒ [1] ⇒ [1] ⇒ [5]

15: [0] ⇒ [0] ⇒ [1] ⇒ [5]      1115: [1] ⇒ [1] ⇒ [1] ⇒ [5]

e.g., **CD**

5: [0] ⇒ [0] ⇒ [5]      115: [1] ⇒ [1] ⇒ [5]

15: [0] ⇒ [1] ⇒ [5]

• Press [◀, ▶] to display the previous or next still picture.

• Useful functions during still picture play (⇒ 35).

### To return to the Direct Navigator screen

Press [■].

### To exit the screen

Press [DIRECT NAVIGATOR].

### ■ To show the picture properties

Press [STATUS] twice.

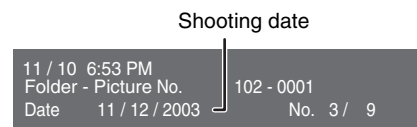

### To exit the picture properties screen

Press [STATUS].

### Note

Still pictures cannot be played during recording or transferring (dubbing).

### To select JPEG Menu

**CD** [with MP3 files and still pictures (JPEG/TIFF)]

The screen shown below is displayed when you insert a disc containing MP3 files and still pictures (JPEG/TIFF).

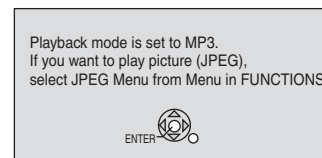

## 1 Press [RETURN].

## 2 Press [FUNCTIONS].

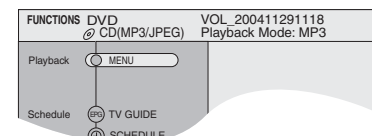

## 3 Press [▲, ▼] to select "MENU" and press [ENTER].

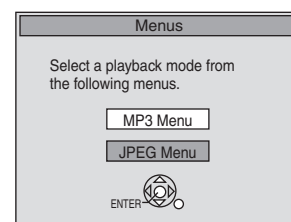

## 4 Press [▲, ▼] to select "JPEG Menu" and press [ENTER].

## Useful functions during still picture play

### Start Slide Show

HDD RAM SD CD

You can display still pictures one by one with constant interval. While the Picture (JPEG) View screen is displayed

- 1 Press **[▲, ▼, ◀, ▶]** to select "Folder" and press **[SUB MENU]**.
- 2 Press **[▲, ▼]** to select "Start Slide Show" and press **[ENTER]**.

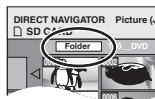

- To change the display timing
- 1 Press **[▲, ▼]** to select "Slide Interval" in step 2 and press **[ENTER]**.
  - 2 Press **[◀, ▶]** to select the desired timing (0–30 seconds) and press **[ENTER]**.

### Rotate

HDD RAM SD CD

- 1 Press **[SUB MENU]**.
- 2 Press **[▲, ▼]** to select "Rotate Right" or "Rotate Left" and press **[ENTER]**.

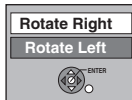

- Rotation information will not be stored.

### Zoom in Zoom out

HDD RAM SD CD

- 1 Press **[SUB MENU]**.
- 2 Press **[▲, ▼]** to select "Zoom in" and press **[ENTER]**.

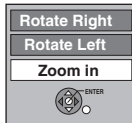

- To return the picture to its original size, press **[▲, ▼]** to select "Zoom out" in step 2 and press **[ENTER]**.
- When zooming in, the picture may be cut off.
- The enlargement information will not be stored.
- The "Zoom in/Zoom out" function is only available for still pictures smaller than 640×480 pixels.

### Erase

HDD RAM SD

- 1 Press **[ERASE]**.
- 2 Press **[◀, ▶]** to select "Erase" and press **[ENTER]**.

- Once erased, the recorded contents are lost and cannot be restored. Make certain before proceeding.

### To select the still pictures in another folder

(⇒ 9, Structure of folders displayed by this unit)

- ① Press **[▲, ▼, ◀, ▶]** to select "Folder" and press **[ENTER]**.
- ② Press **[▲, ▼]** to select the folder and press **[ENTER]**.



You can also select folders with the numbered buttons.

e.g., 5: [0] ⇒ [0] ⇒ [5]  
15: [0] ⇒ [1] ⇒ [5]  
115: [1] ⇒ [1] ⇒ [5]

### To switch to another higher folder

If there is a multiple number of higher folders recognizable, While the screen on the right appears

- 1 Press **[SUB MENU]**.
- 2 Press **[▲, ▼]** to select "Select Folder" and press **[ENTER]**.
- 3 Press **[◀, ▶]** to select the higher folder and press **[ENTER]**.
- 4 Press **[▲, ▼]** to select the desired folder and press **[ENTER]**.

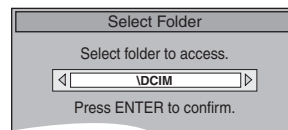
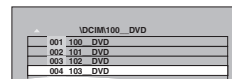

### Regarding still pictures (JPEG, TIFF)

HDD RAM SD

- Compatible formats: DCF\* compliant (Content recorded on a digital camera, etc.)
- \* Design rule for Camera File system: unified standard established by Japan Electronics and Information Technology Industries Association (JEITA).
- File format: JPEG, TIFF (non-compressed RGB chunky format)
- Number of pixels: between 34×34 and 6144×4096 pixels (Sub sampling is 4:2:2 or 4:2:0)
- This unit can handle a maximum of 3000 files and 300 folders (including higher folders).
- Operation may take time to complete when playing TIFF format still pictures, or when there are many files and/or folders, some files may not display or be playable.
- This unit is not compatible with MOTION JPEG.

CD

- Compatible formats: ISO9660 level 1 or 2 (except for extended formats), Joliet
- Maximum number of files and folders recognizable: 999 files and 99 folders
- This unit is compatible with multi-session but reading or play of the disc may take time if there are a lot of sessions.
- Operation may take time to complete when there are many files and/or folders and some files may not display or be playable.
- The display order on this unit may differ from how the order is displayed on a computer.
- Depending on how you create the disc (writing software), files and folders may not play in the order you numbered them.
- This unit is not compatible with packet-write format.
- File format: JPEG, TIFF (non-compressed RGB chunky format)
- Files must have the extension ".jpg", ".JPG", ".tif" or ".TIF".
- Number of pixels: between 34×34 and 6144×4096 pixels (Sub sampling is 4:2:2 or 4:2:0)
- Operation may take time to complete when playing TIFF format still pictures.
- This unit is not compatible with MOTION JPEG.
- You can play MP3 and still pictures (JPEG/TIFF) on this unit by making folders as shown below. However depending on how you create the disc (writing software), play may not be in the order you numbered the folders.
- English alphabet and Arabic numerals are displayed correctly. Other characters may not be displayed correctly.
- When the highest level folders are "DCIM" folders, they are displayed first on the tree.

### Structure of still pictures

Files inside a folder are displayed in the order they were updated or taken.

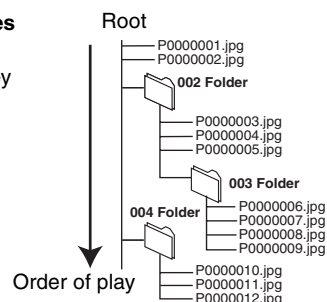

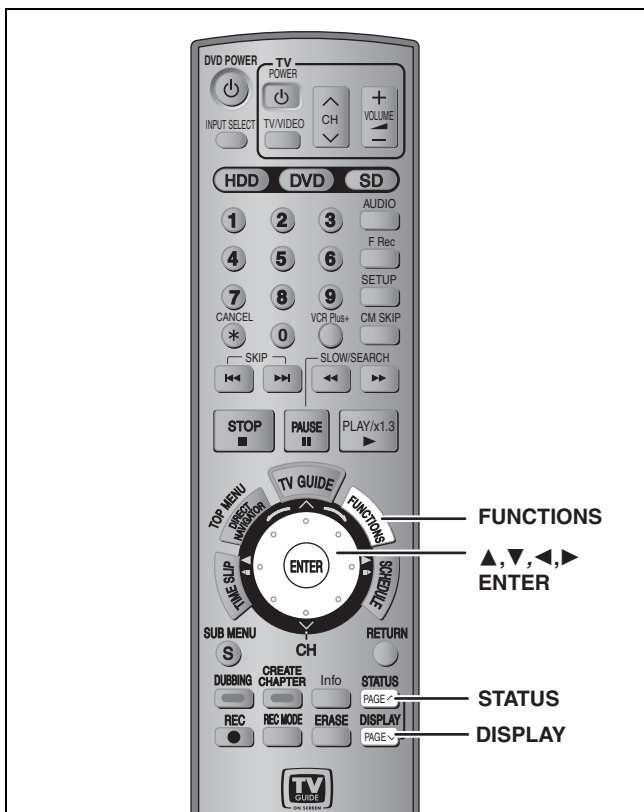

## Using on-screen menus

### Common procedures

#### 1 Press [DISPLAY].

Menu	Item	Setting
Disc	Soundtrack	1 DD Digital 2/0ch
Play	Subtitle	Off
Video	Audio channel	Stereo
Audio		
Other		

• Depending on the condition of the unit (playing, stopped, etc.) and disc contents, there are some items that you cannot select or change.

#### 2 Press [▲, ▼] to select the menu and press [▶].

#### 3 Press [▲, ▼] to select the item and press [▶].

#### 4 Press [▲, ▼] to select the setting.

• Some items can be changed by pressing [ENTER].

#### To clear the on-screen menus

Press [DISPLAY].

### Disc menu—Setting the disc content

#### Soundtrack\*

**HDD RAM -R -RW(V) +R -RW(VR)**

The disc's audio attributes appear.

**DVD-V DVD-A**

Select the audio and language (⇒ below, Audio attribute, Language).

#### Subtitle\*

**DVD-V DVD-A**

Turn the subtitle on/off and select the language (⇒ below, Language).

**HDD RAM -R -RW(V) +R -RW(VR)** (Only discs that contain subtitle on/off information)

Turn the subtitle on/off.

- Subtitle on/off information cannot be recorded using this unit.
- If the subtitles overlap closed captions recorded on discs, turn the subtitles off.

#### Audio channel **HDD RAM -RW(VR) VCD**

⇒ 32, Changing audio during play

#### Angle\* **DVD-V DVD-A**

Change the number to select an angle.

#### Still-P (Still picture) **DVD-A**

Selects the play method for still pictures.

**Slide Show:** Plays according to the default order on the disc.

**Page:** Select the still picture number and play.

• **RANDOM:** Plays in random order.

• **Return:** Returns to the default still picture on the disc.

#### PBC (Playback control ⇒ 68) **VCD**

Indicates whether menu play (playback control) is on or off.

\* You may have to use the menus (⇒ 31) on the disc to make changes.

• The display changes according to the disc content. You cannot change when there is no recording.

#### Audio attribute

LPCM/PPCM/DD Digital/DTS/MPEG:	Signal type
k (kHz):	Sampling frequency
b (bit):	Number of bits
ch (channel):	Number of channels

#### Language

ENG: English	SVE: Swedish	CHI: Chinese
FRA: French	NOR: Norwegian	KOR: Korean
DEU: German	DAN: Danish	MAL: Malay
ITA: Italian	POR: Portuguese	VIE: Vietnamese
ESP: Spanish	RUS: Russian	THA: Thai
NLD: Dutch	JPN: Japanese	*: Others

### Play menu—Change the play sequence

This function works only when the elapsed play time is displayed. Select the item for repeat play. Depending on the disc, the items that can be selected will differ.

#### Repeat play

- All **CD** (excluding MP3 discs) **VCD**
- Chapter **HDD RAM -R -RW(V) +R DVD-V -RW(VR)**
- Group **DVD-A CD** (MP3 discs only)
- Playlists **HDD RAM**
- Title **HDD RAM -R -RW(V) +R DVD-V -RW(VR)**
- Track **DVD-A CD VCD**

Select "Off" to cancel.

## Video menu—Change the picture quality

Picture **HDD** **RAM** **-R** **-RW(V)** **+R** **DVD-V** **DVD-A** **-RW(VR)** **VCD**

To select the picture quality mode during play.

- **Normal:** Default setting
- **Soft:** Soft picture with fewer video artifacts
- **Fine:** Details are sharper
- **Cinema:** Mellows movies, enhances detail in dark scenes.
- **User:** You can make further adjustments.  
Press [**▲**, **▼**, **◀**, **▶**] to select “Detail picture adjustment” and press [ENTER].

### Contrast

Increases the contrast between light and dark parts of the picture.

### Brightness

Brightens the picture.

### Sharpness

Adjust the sharpness of the edges of the horizontal lines.

### Color

Adjusts the shade of the picture’s color.

### Gamma

Increases the brightness of the center ranges to improve detail and contrast in dark scenes.

### Integrated DNR

Reduces mosaic noise and character smudging.

## MPEG-DNR (When any item other than “User” is selected)

**HDD** **RAM** **-R** **-RW(V)** **+R** **DVD-V** **DVD-A** **-RW(VR)** **VCD**

Reduces noise and picture degradation.

On ↔ Off

## Progressive\* (⇒ 68)

Select “On” to enable progressive output.

- Select “Off” if the picture is stretched horizontally.
- When progressive output is on, closed captions cannot be displayed.

## Transfer\* [When “Progressive” (⇒ above) is set to “On”.]

Select the method of conversion for progressive output to suit the type of material being played (⇒ 68, Film and video).

- **Auto1 (normal):**  
Detects 24 frame-per-second film content and appropriately converts it.
- **Auto2:** Compatible with 30 frame-per-second film content in addition to 24 frame-per-second film content. (Picture distortion may occur depending on the content)
- **Video:** Select when using “Auto1” and “Auto2”, and the video content is distorted.

## Line-in NR (Only when IN1, IN2, IN3 or DV is selected)

Reduces video tape noise while transferring (dubbing). Depending on the video tape, jittering may occur.

- **Automatic:** Noise reduction only works on picture input from a video tape.
- **On:** Noise reduction works for any video input.
- **Off:** Noise reduction is off. Select when you want to record input as is.

\* Only when you have selected “480p” in “TV Type” (⇒ 18).

## Audio menu—Change the sound effect

V.S.S. **HDD** **RAM** **-R** **-RW(V)** **+R** **DVD-V** **DVD-A** **-RW(VR)**

(Dolby Digital with 2 channels or more only)

Enjoy a surround-like effect if you are using two front speakers only.

- Turn V.S.S. off if it causes distortion. (Check the surround function on the connected equipment.)
- V.S.S. does not work for SAP recordings.

## Dialog Enhancer **RAM** **-RW(V)** **+R** **DVD-V** **DVD-A** **-RW(VR)**

(Dolby Digital with 3 channels or more only, including a center channel)

The volume of the center channel is raised to make dialog easier to hear.

## Other menu—Change the display position

### Position

1 (Standard)–5: The higher the setting the lower the on-screen menu moves.

## FUNCTIONS window

By using the FUNCTIONS window you may access the main functions quickly and easily.

### 1 While stopped

Press [FUNCTIONS].

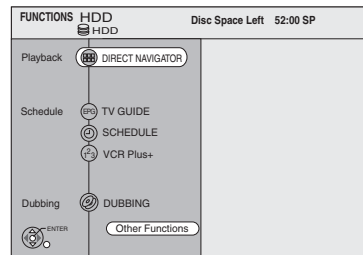

Functions displayed depend on the selected drive or type of disc.

### 2 Press [**▲**, **▼**] to select an item and press [ENTER].

- If you select “Other Functions”, press [**▲**, **▼**] to select an item and press [ENTER].

### To exit the FUNCTIONS window

Press [FUNCTIONS].

## Status messages

### Press [STATUS].

The display changes each time you press the button.

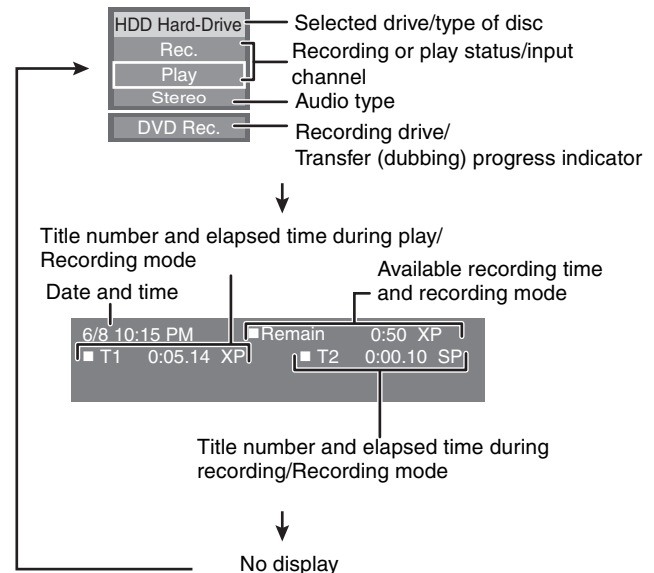

# Editing titles/chapters

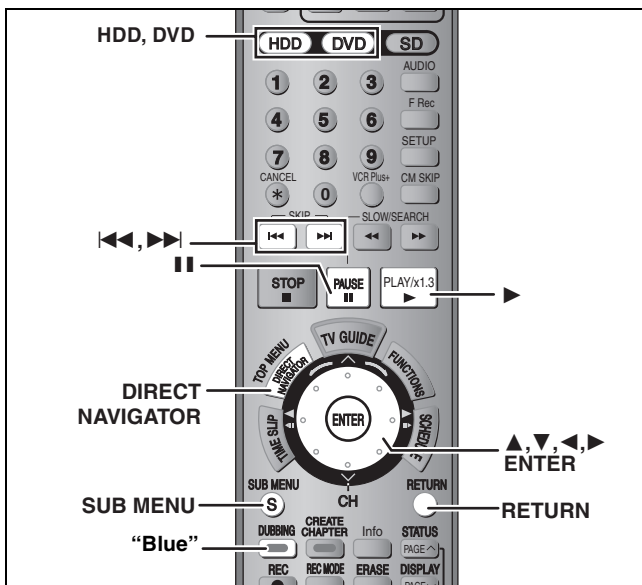

**HDD RAM -R -RW(V) +R**

**Title/Chapter**  
Programs are recorded as a single title consisting of one chapter.

Start ————— End

Chapter

↓

You can divide a title into multiple chapters. **HDD RAM** (⇒ 32, 39)

Start ————— End

Chapter Chapter Chapter Chapter

↓

You can change the order of chapters and create a playlist (⇒ 40). **HDD RAM**

• Titles are divided into about 5-minute chapters after finalizing (⇒ 52). **-R -RW(V) +R**

- The maximum number of items on a disc
  - HDD**
    - Titles: 500
    - Chapters: Approximately 1000 per title (Depends on the state of recording.)
  - RAM -R -RW(V) +R**
    - Titles: 99 (+R 49 titles)
    - Chapters: Approximately 1000 (+R Approximately 254) (Depends on the state of recording.)

**Note**

- Once erased, divided or shortened, recorded content cannot be restored to its original state. Make certain before proceeding.
- You cannot edit during recording or transferring (dubbing), etc.
- Restricted recording information remains even after editing (e.g. dividing a title, etc).

## Editing titles/chapters and playing chapters

You can modify (remove unnecessary parts, divide, etc.) recorded programs.

- Preparation**
- Turn on the television and select the appropriate video input to suit the connection to this unit.
  - Turn the unit on.
  - Press [HDD] or [DVD] to select the drive containing the recorded title to be edited.
  - **RAM** Release protection (⇒ 50).

- 1 During play or while stopped  
Press [DIRECT NAVIGATOR].
- 2 **HDD RAM**  
Press the “Blue” button to select “Video”.
- 3 Press [▲, ▼, ◀, ▶] to select the title.

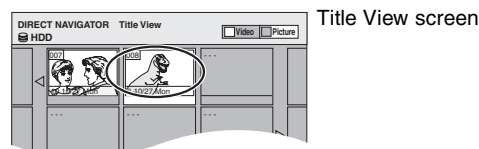

**To show other pages**  
Press [▲, ▼, ◀, ▶] to select “Previous” or “Next” and press [ENTER].  
• You can also press [◀◀, ▶▶] to show other pages.

**Multiple editing**  
Select with [▲, ▼, ◀, ▶] and press [■]. (Repeat.)  
A check mark appears. Press [■] again to cancel.

- 4 Press [SUB MENU].
- 5 Press [▲, ▼] to select the operation and press [ENTER].  
• If you select “Edit Title”, press [▲, ▼] to select the operation and press [ENTER] (⇒ 39).

Refer to “Title operations” (⇒ 39).

Switching the Direct Navigator appearance ⇒ 30

Playing still pictures (JPEG/TIFF) ⇒ 34, Step 3

- If you select “View Chapters”
- 6 Press [▲, ▼, ◀, ▶] to select the chapter.  
To start play ⇒ Press [ENTER].  
To edit ⇒ Step 7.

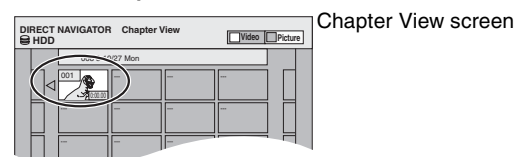

- To show other pages/Multiple editing (⇒ above)
- 7 Press [SUB MENU], then [▲, ▼] to select the operation and press [ENTER].

Refer to “Chapter operations” (⇒ 39).

• You can go back to the Title View.

**To return to the previous screen**  
Press [RETURN].

**To exit the screen**  
Press [DIRECT NAVIGATOR].

## Title operations

After performing steps 1–5 (⇒ 38)

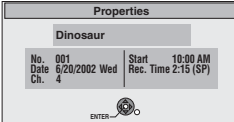
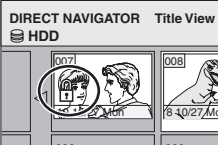
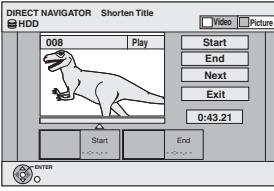
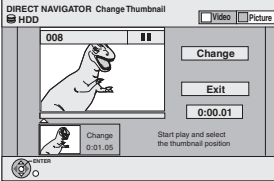
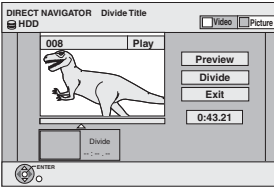
<b>Erase Title*</b> <b>HDD RAM -R -RW(V) +R</b> (⇒ below, “For quicker editing”)	<b>Press [◀, ▶] to select “Erase” and press [ENTER].</b> <ul style="list-style-type: none"> <li>•Once erased, the recorded contents are lost and cannot be restored. Make certain before proceeding.</li> <li>•The available recording space on DVD-R or +R does not increase when you erase titles.</li> <li>•Available recording space on DVD-RW (DVD-Video format) increases only when the last recorded title is erased. It does not increase if other titles are erased.</li> </ul>
<b>Properties</b> <b>HDD RAM -R -RW(V) +R -RW(VR)</b>	Information (e.g., time and date) is shown. <ul style="list-style-type: none"> <li>•Press [ENTER] to exit the screen.</li> </ul> 
<b>Title Name</b> <b>HDD RAM -R -RW(V) +R</b>	You can give names to recorded titles. ⇒ 53, Entering text
<b>Setup Protection*</b> <b>Cancel Protection*</b> <b>HDD RAM</b>	If set, this will protect the title from accidental erasure. <b>Press [◀, ▶] to select “Yes” and press [ENTER].</b> The lock symbol appears when the title is protected. 
<b>Shorten Title</b> <b>HDD RAM</b> (⇒ below, “For quicker editing”)	You can remove unnecessary parts of the recording such as commercials. <ol style="list-style-type: none"> <li>① <b>Press [ENTER] at the start point and end point of the section you want to erase.</b></li> <li>② <b>Press [▲, ▼] to select “Exit” and press [ENTER].</b>  <ul style="list-style-type: none"> <li>•Select “Next” and press [ENTER] to erase other sections.</li> </ul> </li> <li>③ <b>Press [◀, ▶] to select “Erase” and press [ENTER].</b></li> </ol> 
<b>Change Thumbnail</b> <b>HDD RAM -R -RW(V) +R</b> (⇒ below, “For quicker editing”)	You can change the image to be shown as the thumbnail picture in the Title View. <ol style="list-style-type: none"> <li>① <b>Press [▶] (PLAY) to start play.</b></li> <li>② <b>Press [ENTER] when the image you want to use as a thumbnail is shown.</b>  <b>To change the thumbnail</b>            Restart play and press [▲, ▼] to select “Change”, then press [ENTER] at the point you want to change.</li> <li>③ <b>Press [▲, ▼] to select “Exit” and press [ENTER].</b></li> </ol> 
<b>Divide Title</b> <b>HDD RAM</b> (⇒ below, “For quicker editing”)	You can divide a title into two. <ol style="list-style-type: none"> <li>① <b>Press [ENTER] at the point you want to divide the title.</b></li> <li>② <b>Press [▲, ▼] to select “Exit” and press [ENTER].</b></li> <li>③ <b>Press [◀, ▶] to select “Divide” and press [ENTER].</b>  <b>To confirm the division point</b>            Press [▲, ▼] to select “Preview” and press [ENTER]. (The unit plays 10 seconds before and after the division point.)  <b>To change the division point</b>            Restart play and press [▲, ▼] to select “Divide”, then press [ENTER] at the point where you want to divide the title.</li> </ol> <p><b>Note</b></p> <ul style="list-style-type: none"> <li>•The divided titles retain the name and CPRM property (⇒ 68) of the original title.</li> <li>•Video and audio just before and after the dividing point may momentarily cut out.</li> </ul> 

\* Multiple editing is possible.

## Chapter operations

After performing steps 1–7 (⇒ 38)

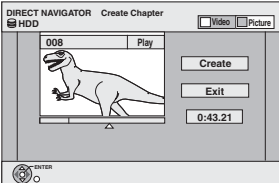
<b>Erase Chapter*</b> <b>HDD RAM</b>	<b>Press [◀, ▶] to select “Erase” and press [ENTER].</b> <ul style="list-style-type: none"> <li>•Once erased, the recorded contents are lost and cannot be restored. Make certain before proceeding.</li> </ul>
<b>Create Chapter</b> <b>HDD RAM</b> (⇒ below, “For quicker editing”)	Select the point where you want to start a new chapter while viewing the title. <ol style="list-style-type: none"> <li>① <b>Press [ENTER] at the point you want to divide.</b>  <ul style="list-style-type: none"> <li>•Repeat this step to divide at other points.</li> </ul> </li> <li>② <b>Press [▲, ▼] to select “Exit” and press [ENTER].</b></li> </ol> 
<b>Combine Chapters</b> <b>HDD RAM</b>	<b>Press [◀, ▶] to select “Combine” and press [ENTER].</b> <ul style="list-style-type: none"> <li>•The selected chapter and following chapter are combined.</li> </ul>

\* Multiple editing is possible.

### For quicker editing

- Use search, slow-motion (⇒ 31) or Time Slip (⇒ 32) to find the desired point.
- Press [◀◀, ▶▶] to skip to the end of a title.

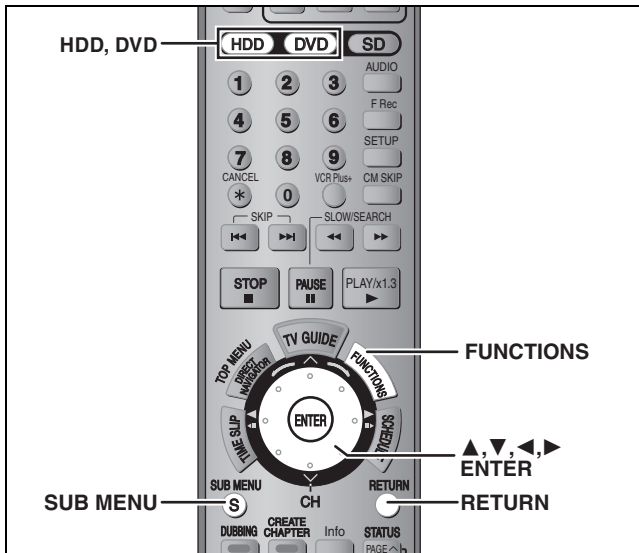

You can arrange the chapters (⇒ 38) to create a playlist.

Title			Title	
Chapter	Chapter	Chapter	Chapter	Chapter

↓

Playlist	Chapter	Chapter
----------	---------	---------

↓

Transferring (dubbing) (⇒ 43) a playlist will create a title.

- Playlists are not recorded separately so this doesn't use much capacity.
- Editing chapters in a playlist does not modify the source titles and source chapters.

### HDD RAM

- The maximum number of items on a disc
  - Playlists: 99
  - Chapters in playlists: Approximately 1000 (Depends on the state of recording.)
- If you exceed the maximum numbers of items for a disc, all the items entered will not be recorded.

## Creating playlists

### HDD RAM

#### Preparation

- Turn on the television and select the appropriate video input to suit the connection to this unit.
- Turn the unit on.
- Press [HDD] or [DVD] to select the drive containing the recorded title to be edited.
- [RAM] Release disc or cartridge protection (⇒ 50).
- You cannot create or edit a playlist while recording or while transferring (dubbing).

- 1 While stopped  
Press [FUNCTIONS].
- 2 Press [▲, ▼] to select “Other Functions” and press [ENTER].

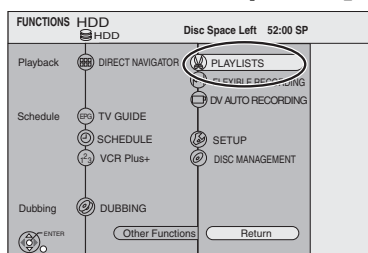

- 3 Press [▲, ▼] to select “PLAYLISTS” and press [ENTER].
- 4 Press [▲, ▼, ◀, ▶] to select “Create” and press [ENTER].

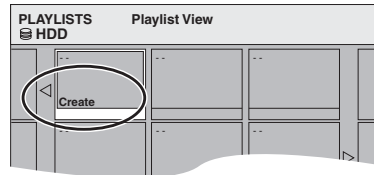

- 5 Press [◀, ▶] to select the source title and press [▼].
  - Press [ENTER] to select all the chapters in the title, then skip to step 7.

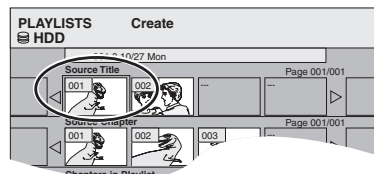

- 6 Press [◀, ▶] to select the chapter you want to add to a playlist and press [ENTER].
  - Press [▲] to cancel.

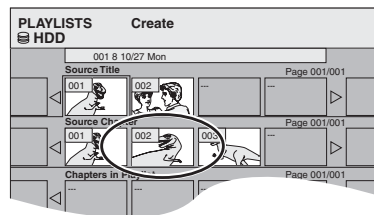

- You can also create a new chapter from the source title. Press [SUB MENU] to select “Create Chapter” and press [ENTER] (⇒ 39, Create Chapter).

- 7 Press [◀, ▶] to select the position to insert the chapter and press [ENTER].

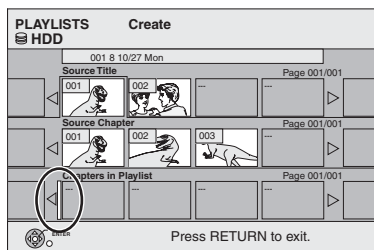

- Press [▲] to select other source titles.
- Repeat steps 6–7 to add other chapters.

- 8 Press [RETURN].

All the selected scenes become the playlist.

To return to the previous screen  
Press [RETURN].

To exit the screen  
Press [RETURN] several times.



## Editing and playing playlists/chapters

**HDD** **RAM**

**-RW(VR)** (Play only)

- 1** While stopped  
Press [FUNCTIONS].
- 2** Press [▲, ▼] to select “Other Functions” and press [ENTER].
- 3** Press [▲, ▼] to select “PLAYLISTS” and press [ENTER].
- 4** Press [▲, ▼, ◀, ▶] to select the playlist.  
To start play → Press [ENTER].  
To edit → Step 5.

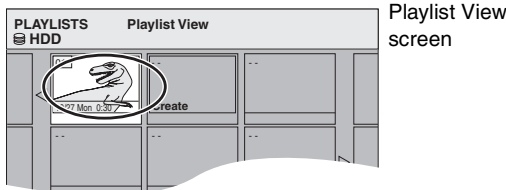

- To show other pages/Multiple editing (⇒ 38)
- 5** Press [SUB MENU], then [▲, ▼] to select the operation and press [ENTER].  
•If you select “Edit”, press [▲, ▼] to select the operation and press [ENTER].

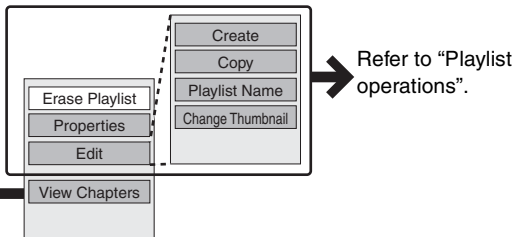

If you select “View Chapters”

- 6** Press [▲, ▼, ◀, ▶] to select the chapter.  
To start play → Press [ENTER].  
To edit → Step 7.

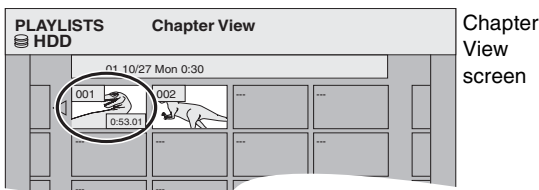

- To show other pages/Multiple editing (⇒ 38)
- 7** Press [SUB MENU], then [▲, ▼] to select the operation and press [ENTER].

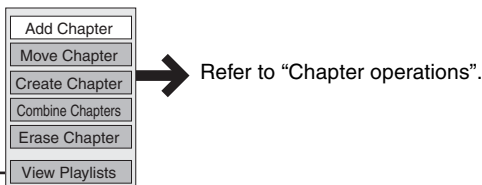

•You can go back to the Playlist View.

**To return to the previous screen**  
Press [RETURN].

**To exit the screen**  
Press [RETURN] several times.

## Playlist operations

After performing steps 1–5 (⇒ left)

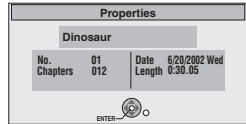
<b>Erase Playlist*</b> <b>HDD</b> <b>RAM</b>	Press [◀, ▶] to select “Erase” and press [ENTER]. Once erased, the playlists are lost and cannot be restored. Make certain before proceeding.
<b>Properties</b> <b>HDD</b> <b>RAM</b> <b>-RW(VR)</b>	Playlist information (e.g., length and date) is shown. •Press [ENTER] to exit the screen. 
<b>Create</b> <b>HDD</b> <b>RAM</b>	⇒ 40, Creating playlists, Step 5–8
<b>Copy*</b> <b>HDD</b> <b>RAM</b>	Press [◀, ▶] to select “Copy” and press [ENTER]. •The copied playlist becomes the newest one in the playlist view screen.
<b>Playlist Name</b> <b>HDD</b> <b>RAM</b>	⇒ 53, Entering text
<b>Change Thumbnail</b> <b>HDD</b> <b>RAM</b>	⇒ 39, Change Thumbnail

\*Multiple editing is possible.

## Chapter operations

**HDD** **RAM**

After performing steps 1–7 (⇒ left)

•Editing chapters in a playlist does not modify the source titles and source chapters.

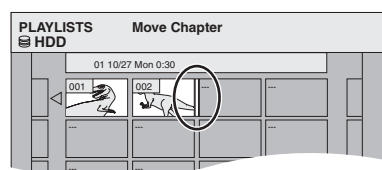
<b>Add Chapter</b>	⇒ 40, Creating playlists, Step 5–7
<b>Move Chapter</b>	Press [▲, ▼, ◀, ▶] to select the position to insert the chapter and press [ENTER]. 
<b>Create Chapter</b>	⇒ 39, Create Chapter
<b>Combine Chapters</b>	⇒ 39, Combine Chapters
<b>Erase Chapter*</b>	⇒ 39, Erase Chapter The playlist itself is erased if you erase all the chapters in it.

\*Multiple editing is possible.

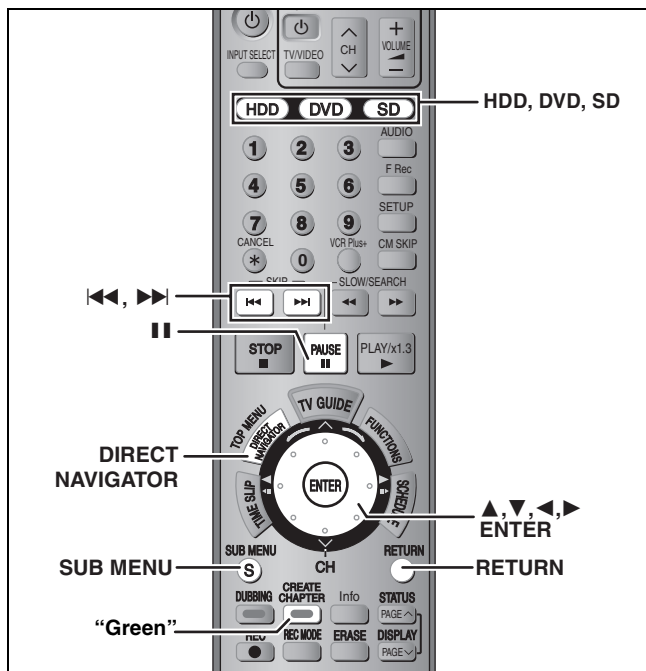

### HDD RAM SD

• You can use SD Memory Cards with capacities from 8 MB to 1 GB (→ 9).

### Preparation

- Press [HDD], [DVD] or [SD] to select the drive.
- [RAM SD] Release protection (→ 50, Setting the protection).

**1 Press [DIRECT NAVIGATOR].**

**2** **HDD RAM**  
Press the “Green” button to select “Picture”.

**3 Press [▲, ▼, ◀, ▶] to select the still picture.**

#### To show other pages

Press [▲, ▼, ◀, ▶] to select “Previous” or “Next” and press [ENTER].

• You can also press [◀◀, ▶▶] to show other pages.

#### Multiple editing

Select with [▲, ▼, ◀, ▶] and press [■]. (Repeat.) A check mark appears. Press [■] again to cancel.

• To select the still pictures in another folder (→ 35)

**4 Press [SUB MENU], then [▲, ▼] to select the operation and press [ENTER].**

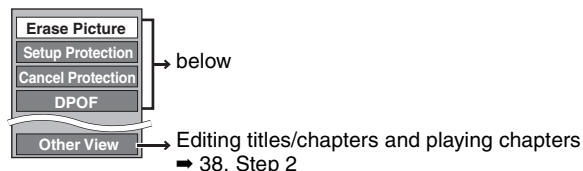

### ■ To edit still picture folders

In step 3 (→ above)

① Press [▲, ▼, ◀, ▶] to select “Folder” and press [ENTER].

② Press [▲, ▼] to select the folder.

• To show other pages/Multiple editing (→ above)

③ Press [SUB MENU], then [▲, ▼] to select the operation and press [ENTER].

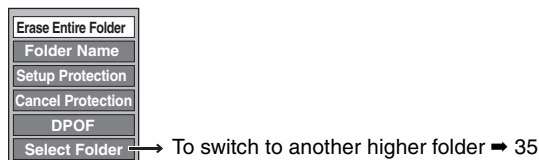

#### To return to the previous screen

Press [RETURN].

#### To exit the screen

Press [DIRECT NAVIGATOR].

## Picture and folder operation

After performing steps 1–4

<p>Erase Picture* Erase Entire Folder* <b>HDD RAM SD</b></p>	<p><b>Press [◀, ▶] to select “Erase” and press [ENTER].</b></p> <ul style="list-style-type: none"> <li>• Once erased, the recorded contents are lost and cannot be restored. Make certain before proceeding.</li> <li>• When erasing a folder, the files not containing still pictures will also be erased if they are inside the folder. (This does not apply to folders under the folder concerned.)</li> </ul>
<p>Folder Name <b>HDD RAM SD</b></p>	<p>You can give names to still picture folders. → 53, Entering text</p> <ul style="list-style-type: none"> <li>• Folder names input using this unit may not be displayed on other equipment.</li> </ul>
<p>Setup Protection* Cancel Protection* <b>HDD RAM SD</b></p>	<p>If set, this will protect the still picture or folder from accidental erasure.</p> <p><b>Press [◀, ▶] to select “Yes” and press [ENTER].</b></p> <p>The lock symbol appears when the still picture or folder is protected.</p> <ul style="list-style-type: none"> <li>• Even if the protection setting is used by this unit to protect a folder, the folder may be erased by another unit.</li> </ul>
<p>DPOF* <b>SD</b></p>	<p>You can select a whole folder or individual pictures for printing and specify the number of prints to be made.</p> <p><b>Press [◀, ▶] to select number of print (0 to 9) and press [ENTER].</b></p> <p>The DPOF mark appears. (This appears on the still pictures inside a folder when you make the DPOF setting for the folder.)</p> <p><b>To cancel the print setting</b> Set the number of prints to “0”.</p> <ul style="list-style-type: none"> <li>• Print settings (DPOF) made using this unit may not be viewable on other equipment.</li> <li>• When this is set by this unit, any settings established by other units will be released.</li> <li>• Settings cannot be made for folders and files not in accordance with DCF standards or if there is no remaining space on the card.</li> </ul>

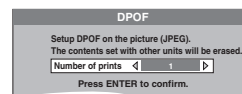
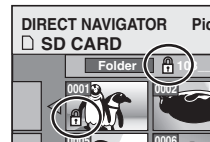

\* Multiple editing is possible.

# Transferring (dubbing) titles or playlists

**HDD** **RAM** **-R** **-RW(V)** **+R**

You can select from a variety of methods to transfer (dub) on this unit.  
You cannot transfer (dub) titles which have been treated to prevent copying.

## Transferring (dubbing) direction

<p>You can transfer (dub) your favorite titles and playlists to an archive disc.</p> <ul style="list-style-type: none"> <li>Transferring (dubbing) a playlist will create a title.</li> </ul>	<p>When you want to re-edit finalized content on a DVD-R, etc.</p>
<div style="display: flex; justify-content: space-around;"> <div style="text-align: center;"> <p><b>High speed mode</b></p> <p><b>Normal speed mode</b></p> </div> <div style="text-align: center;"> <p><b>High speed mode*1</b></p> <p><b>Normal speed mode</b></p> </div> </div>	<div style="text-align: center;"> <p><b>Normal speed mode</b></p> </div>
<p><b>High speed mode</b></p>	<p>*When you want to play a transferred (dubbed) disc on other equipment, you must finalize the disc after transferring (dubbing) (⇒ 52, 68).</p> <p>*1 Before recording to HDD, set "Rec. for High-Speed Dubbing" to "On" (⇒ 22).</p> <p>*2 DVD-R, DVD-RW (DVD-Video format) and +R</p>

**Normal speed mode:** Select XP, SP, LP, EP or FR as the recording mode for transferring (dubbing) (⇒ 21).

## Transferring (dubbing) mode

<p><b>Transferring (dubbing) a title or a playlist</b></p> <p>↓</p> <p><b>One Touch Transfer (dubbing) (⇒ 44)</b></p>	<p><b>Transferring (dubbing) multiple titles and playlists together</b></p> <p>↓</p> <p><b>Transferring (dubbing) using the transferring (dubbing) list (⇒ 44)</b></p> <p>↓</p> <p><b>You can select transferring (dubbing) speed mode and picture quality (⇒ below)</b></p>
---	--

## Transferring (dubbing) speed mode types and features

	High speed	Normal speed (XP, SP, LP, EP, FR)
<b>Features</b>	You can transfer (dub) in a very short amount of time. You can transfer (dub) even faster if you use a high speed recording compatible disc. You can record and play using the HDD while high speed transferring (dubbing).	You can record for a long period of time on 1 disc. For example, using LP mode, you can record approximately 4 hours on 1 (4.7 GB) disc (⇒ 21). e.g., 1 hour TV drama 
<b>Transferring (dubbing) times</b>	⇒ below, Approximate transferring (dubbing) times	The same amount of time it takes to record the source
<b>Picture quality</b>	Original picture quality	Can change*1
<b>Are chapters/thumbnails maintained?</b>	Yes*2	No (One title is recorded as one chapter. Thumbnails return to the default position.)
<b>Other operations while transferring (dubbing)</b>	You can record/play using the HDD.	No

\*1 If you select a recording mode with better picture quality than the original, the picture quality does not improve. (However, it does prevent against degradation of picture quality.)

\*2 **+R** Up to approx. 100 chapters

When transferring (dubbing) playlists to DVD-R, DVD-RW (DVD-Video format) or +R, the thumbnails may not reflect changes made to them.

## Approximate transferring (dubbing) times (Max. speed)

(excludes time required to write data management information)

HDD		5× high speed recording compatible DVD-RAM	8× high speed recording compatible DVD-R	4× high speed recording compatible DVD-RW	8× high speed recording compatible +R
Recording mode	Recording time				
XP	1 hour	Approx. 12 min.	Approx. 8.7 min.	Approx. 15 min.	Approx. 8.7 min.
SP		Approx. 6 min.	Approx. 3.8 min.	Approx. 7.5 min.	Approx. 3.8 min.
LP		Approx. 3 min.	Approx. 1.9 min.	Approx. 3.8 min.	Approx. 1.9 min.
EP (6H)		Approx. 2 min.	Approx. 1.3 min.	Approx. 2.5 min.	Approx. 1.3 min.
EP (8H)		Approx. 1.5 min.	Approx. 56 sec.	Approx. 1.9 min.	Approx. 56 sec.

### Note

- When recording or playing while transferring (dubbing), the unit may not use the maximum recording speed.
- Depending on the condition of the disc, the unit may not transfer (dub) using the maximum speed.

**Regarding high speed transfer (dubbing) to DVD-R, etc.**  
To high speed transfer (dub) titles (or playlists created from those titles), set "Rec. for High-Speed Dubbing" to "On" before recording to the HDD (⇒ 22).

However, in the following cases, transferring (dubbing) to DVD-R, DVD-RW (DVD-Video format) and +R using the high speed mode does not work.

- Playlists created from titles using a variety of recording modes
- Playlists created from multiple titles using FR recording mode
- Playlists mixed with a variety of audio types (Dolby Digital and LPCM, etc.)
- Titles that contain many erased segments.

### Regarding transferring (dubbing) of digital broadcasts that allow "One time only recording"

You can transfer (dub) a recorded title to a CPRM (⇒ 68) compatible DVD-RAM; however, the title is erased from the HDD.

- Titles or playlists cannot be transferred (dubbed) from DVD-RAM to the HDD.
- You cannot use one touch transfer (dubbing). Use the transferring (dubbing) list (⇒ 44).
- Titles will not be transferred (dubbed) if they are protected (⇒ 39).
- You cannot transfer (dub) playlists created from "One time only recording" titles.
- Titles with recording limitations and playlists cannot be registered on the same transferring (dubbing) list.

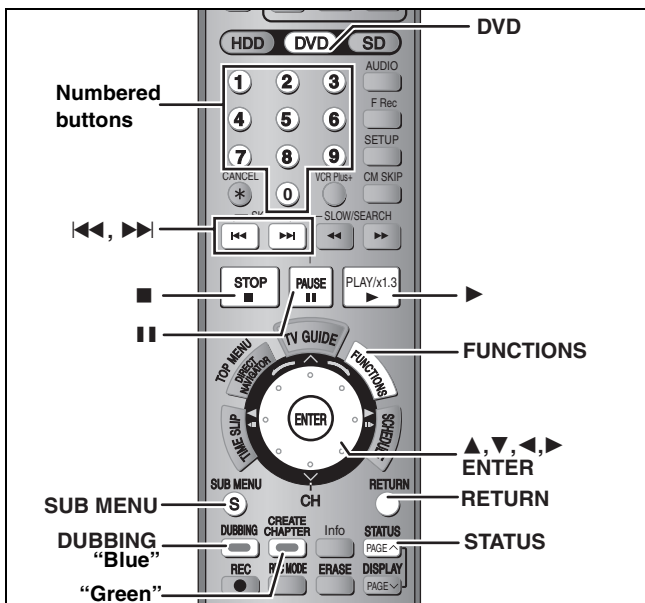

**Preparation**

- Insert a disc that you can use for recording (⇒ 8).
- Confirm that there is enough remaining disc space.

**One Touch Transfer (dubbing)**

HDD → RAM -R -RW(V) +R

With one touch transfer (dubbing), the title currently being played is dubbed without any further setting.

- **-R -RW(V) +R** Select the audio type for recording MTS broadcast from “Select MTS” (⇒ 56).

- 1 Play the title or playlist you want to transfer (dub).
- 2 Press [DUBBING].

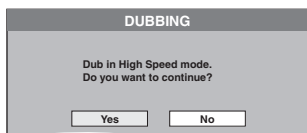

**Selecting the DVD drive speed\***

- 1 Press [▲] to highlight “DVD Drive Speed”.
- 2 Press [◀, ▶] to select “Top Speed Mode” or “Silent Mode” and press [▼].

• Selecting “Silent Mode” means the noise generated by this unit is less than “Top Speed Mode”; however, the time required for transferring (dubbing) will double (approximately).

\*Only when transferring (dubbing) to 5×high speed recording compatible DVD-RAM, 8×high speed recording compatible DVD-R or 8×high speed recording compatible +R in High speed mode

- 3 Press [◀, ▶] to select “Yes” and press [ENTER].

A transfer (dubbing) complete message appears on the screen for a few seconds when transferring (dubbing) is completed.

- The transfer (dubbing) speed and picture quality are set as follows.

The recording mode changes to FR mode if the remaining disc space is exceeded using one of the recording modes indicated below.

HDD → RAM: High speed mode

HDD → -R -RW(V) +R:

Rec. for High-Speed Dubbing setting	
On	Off
High speed mode	Same recording mode used as when recording the source title (XP-EP, FR). • Playlists are transferred (dubbed) in FR mode.

- To stop transferring (dubbing) ⇒ 45
- Recording and playing while transferring (dubbing) ⇒ 45

**Transferring (dubbing) using the transferring (dubbing) list**

HDD ↔ RAM

-RW(VR) → HDD

HDD → -R -RW(V) +R

You can order titles and playlists as desired for transfer (dubbing) to disc.

- Select the audio type for recording MTS broadcasts from “Select MTS” (⇒ 56) when:
  - Transferring (dubbing) to a DVD-R, DVD-RW (DVD-Video format) and +R.
  - When “Audio for XP Recording” is set to “LPCM” (⇒ 56) and you are transferring (dubbing) in XP mode.

- 1 While stopped Press [FUNCTIONS].
- 2 Press [▲, ▼] to select “DUBBING” and press [ENTER].



- If you are not going to change the registered list press [▼] several times (⇒ 45, step 6).

- 3 Set the transfer (dubbing) direction.

- If you are not going to change the dubbing direction, press [▼] (⇒ step 4).

- 1 Press [▲, ▼] to select “Dubbing Direction” and press [▶].
- 2 Press [▲, ▼] to select “Source” and press [ENTER].
- 3 Press [▲, ▼] to select the drive and press [ENTER].
- 4 Press [▲, ▼] to select “Destination” and press [ENTER].
- 5 Press [▲, ▼] to select the drive and press [ENTER].  
The same drive as the transfer (dubbing) source cannot be selected.
- 6 Press [◀] to confirm.

- 4 Set the recording mode.

- If you are not going to change the recording mode, press [▼] (⇒ step 5).

- 1 Press [▲, ▼] to select “Mode” and press [▶].
- 2 Press [▲, ▼] to select “Format” and press [ENTER].
- 3 Press [▲, ▼] to select “Video” and press [ENTER].
- 4 Press [▲, ▼] to select “Recording Mode” and press [ENTER].
- 5 Press [▲, ▼] to select the mode and press [ENTER].
- 6 Press [◀] to confirm.

- 5 Register titles and playlists for transfer (dubbing).

- If you are going to transfer (dub) a registered list without making any changes to it (⇒ 45, step 6).

- 1 Press [▲, ▼] to select “Create List” and press [▶].

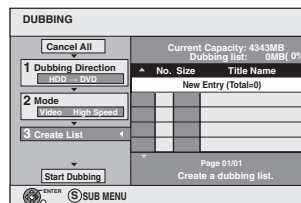

- 2 Press [▲, ▼] to select “New Entry” and press [ENTER].
- 3 Press the “Blue” button to select “Video” or press the “Green” button to select “Playlists”.

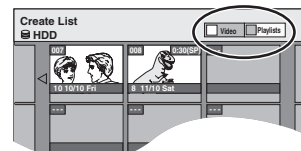

- ④ Press [▲, ▼, ◀, ▶] to select the titles or playlists and press [ENTER].

- When transferring (dubbing) to DVD-R, DVD-RW (DVD-Video format) or +R using high speed mode, only items indicated with “▶▶” can be registered.
- To select a multiple number of items together, press [■] to add the check mark and press [ENTER] (⇒ right, Multiple editing).
- To show other pages (⇒ right)
- To edit the transferring (dubbing) list (⇒ right)

You can register a multiple number of titles and playlists on the transferring (dubbing) list by repeating steps ②–④.

- You cannot start transferring (dubbing) when the value of the “Dubbing list” (⇒ right) exceeds 100 %. (Destination capacity is not sufficient.)

- ⑤ Press [◀] to confirm.

## 6 Press [▲, ▼] to select “Start Dubbing” and press [ENTER].

Selecting the DVD drive speed\*

- 1 Press [▲] to highlight “DVD Drive Speed”.
  - 2 Press [◀, ▶] to select “Top Speed Mode” or “Silent Mode” and press [▼].
- Selecting “Silent Mode” means the noise generated by this unit is less than “Top Speed Mode”, however the time required for transferring (dubbing) will double (approximately).
- \*Only when transferring (dubbing) to 5X high speed recording compatible DVD-RAM, 8X high speed recording compatible DVD-R or 8X high speed recording compatible +R in High speed mode

## 7 Press [◀, ▶] to select “Yes” and press [ENTER] to start transferring (dubbing).

### ■ To stop transferring (dubbing)

Press and hold [RETURN] for 3 seconds.

- If stopped partway, transferring (dubbing) will be up to that point. However, in high speed mode, only titles that have completed transferring (dubbing) at the point stopped are transferred (dubbed). [Even if the title was not transferred (dubbed) to the DVD-R, DVD-RW (DVD-Video format) or +R, the amount of remaining writable disc space becomes less.]

### ■ To return to the previous screen

Press [RETURN].

### ■ Recording and playing while transferring (dubbing)

You can record and play using the HDD while high speed transferring (dubbing).

Press [ENTER] to cancel the screen display.

#### •To confirm the current progress

Press [STATUS].

#### Note

- You cannot perform chasing play or edit, etc. while transferring (dubbing).
- Scheduled recordings executed while transferring (dubbing) are recorded to the HDD regardless of the recording drive settings.
- You cannot play a playlist while transferring (dubbing) titles with “One time only recording” restriction (⇒ 43).

To play DVD-R, DVD-RW (DVD-Video format) and +R on other players, it is necessary to finalize them after transfer (dubbing).

## Transferring (dubbing) list icons and functions

### Transferring (dubbing) list icons



Titles and playlists that can be transferred (dubbed) in high speed mode to DVD-R, etc. (⇒ 22)



Title with “One time only recording” restriction



Titles erased from the HDD by “One time only recording” restriction after transferring (dubbing).



Title or playlist contains still picture(s)  
•Still picture(s) cannot be transferred (dubbed).

### Data size of each registered item

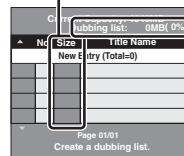

#### Dubbing list:

Data size recorded to the transfer (dubbing) destination

- When transferring (dubbing) at normal speed, the total data size will change according to the recording mode.
- The total data size shown may be larger than the sum of the data sizes for each registered item, because of data management information being written to the transfer (dubbing) destination, etc.

### To show other pages

Press [▲, ▼, ◀, ▶] to select “Previous” or “Next” and press [ENTER].

- You can also press [◀◀, ▶▶] to show other pages.

### Multiple editing

Select with [▲, ▼, ◀, ▶] and press [■]. (Repeat.)

Press [ENTER] to register to the list.

- A check mark appears. Press [■] again to cancel.
- When you switch between the “Video” and “Playlists” tab, the check mark is cancelled.

### ■ To edit the transferring (dubbing) list

Select the item in step 5–④ (⇒ left column)

- 1 Press [SUB MENU].
- 2 Press [▲, ▼] to select the operation and press [ENTER].



#### Erase All:

Erase all items registered on the transferring (dubbing) list.

Press [◀, ▶] to select “Yes” and press [ENTER].

#### Add:

Add new items to the transferring (dubbing) list.

Press [▲, ▼, ◀, ▶] to select the playlists or titles to be added and press [ENTER].

#### Erase:

Erase the selected items.

Press [◀, ▶] to select “Yes” and press [ENTER].

You can also erase multiple items (⇒ above, Multiple editing).

#### Move:

Move selected items or change the order of items on the transferring (dubbing) list.

Press [▲, ▼] to select the destination and press [ENTER].

### To cancel all registered transferring (dubbing) setting and lists

After performing steps 1–2 (⇒ 44, right column)

- 1 Press [▲, ▼] to select “Cancel All” and press [ENTER].
- 2 Press [◀, ▶] to select “Yes” and press [ENTER].

- The settings and lists may be cancelled in the following situations.
  - When a title, still picture, etc. has been recorded or erased at the transfer (dubbing) source
  - When steps have been taken, for instance, to turn off the unit, open the tray, change the transfer (dubbing) direction, etc.

Refer to the control reference on page 44.

## Transferring (dubbing) a finalized DVD-R, DVD-RW (DVD-Video format) and +R

DVD-V → HDD

You can transfer (dub) the content of finalized DVD-R, DVD-RW (DVD-Video format) and +R etc to the HDD and re-edit. While playing a disc, the content being played is transferred (dubbed) to the HDD according to the set time.

- Operations and on screen displays during transfer (dubbing) are also recorded.
- Almost all DVD-Video on sale have been treated to prevent illegal copying, and cannot be transferred (dubbed).
- The following cannot be transferred (dubbed): DVD-Audio, Video CD, Audio CD and so on.

### Preparation

- Insert the finalized disc (⇒ 30).
- Press [DVD] to select the DVD drive.

After performing steps 1–4 (“Format” is automatically set to “DVD-Video”) (⇒ 44, right column)

## 5 Set “Time Limit”.

- If you are not going to change the setting (⇒ step 6).
- **Setting the unit to transferring (dubbing) according to the set time**
  - ① Press [▲, ▼] to select “Time Limit” and press [▶].
  - ② Press [▲, ▼] to select “Time Limit” and press [ENTER].
- Setting the unit to transferring (dubbing) all the content on the disc
  - ③ Press [▲, ▼] to select “Off” and press [ENTER].
  - ④ Press [◀] to confirm.
- Setting the transferring (dubbing) time
  - ③ Press [▲, ▼] to select “On” and press [ENTER].
  - ④ Press [▲, ▼] to select “Set time” and press [ENTER].

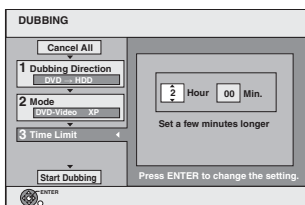

- ⑤ Press [◀, ▶] to select “Hour” and “Min.” and press [▲, ▼] to set the recording time.
  - ⑥ Press [ENTER].
  - ⑦ Press [◀] to confirm.
- Set a few minutes longer than the source title, in order to include the operation time before play begins.
  - You can also set the recording time with the numbered buttons.

## 6 Press [▲, ▼] to select “Start Dubbing” and press [ENTER].

Press [◀, ▶] to select “Yes” and press [ENTER] to start transferring (dubbing).

The disc top menu is displayed.

- Disc play automatically begins from title 1 when “First Title” is selected from the “Playback will start with:” menu when finalizing the disc (⇒ 52).

## 7 When the top menu is displayed

Press [▲, ▼, ◀, ▶] to select the title you want to start transferring (dubbing), and press [ENTER].

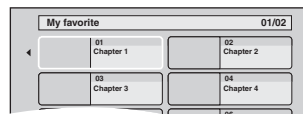

While playing in order, all the titles after the selected title are recorded until the set time. (After the last title on the disc has finished playing the top menu is recorded until the set time is reached.)

### To return to the previous screen

Press [RETURN].

### To stop transferring (dubbing)

Press [■].

You can also press and hold [RETURN] for 3 seconds to stop transferring (dubbing).

- If stopped partway, transferring (dubbing) will be up to that point.

### Note

- The screen saver on the right is recorded at the beginning.
- The content is recorded as 1 title from the start of transfer (dubbing) to the end.
- If play does not begin automatically or if the top menu does not display automatically, press [▶] (PLAY) to start.
- Even if you transfer (dub) a high quality video/audio DVD, the original picture and audio quality cannot be exactly replicated.



# Recording from a video cassette recorder

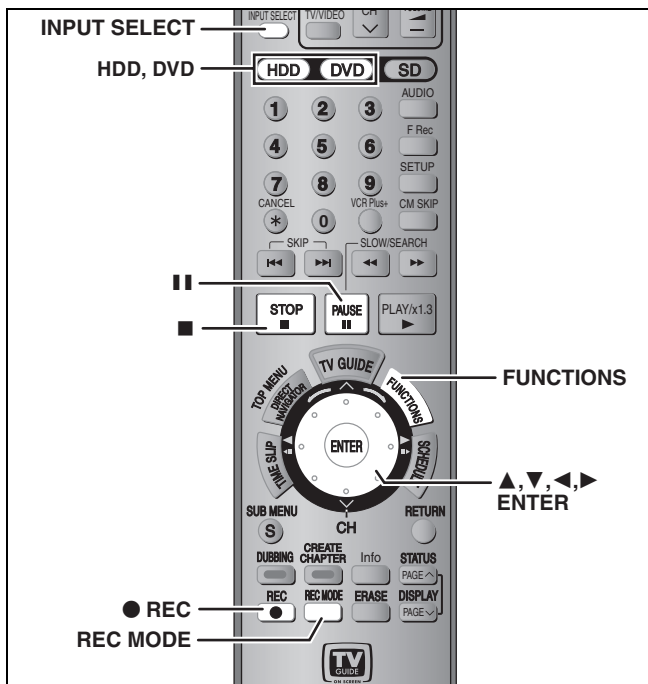

e.g.: Connecting other video equipment to the IN2 or DV input terminals

You can also connect to the IN1 or IN3 input terminals on the rear.

- Turn off the unit and other video equipment before connecting.

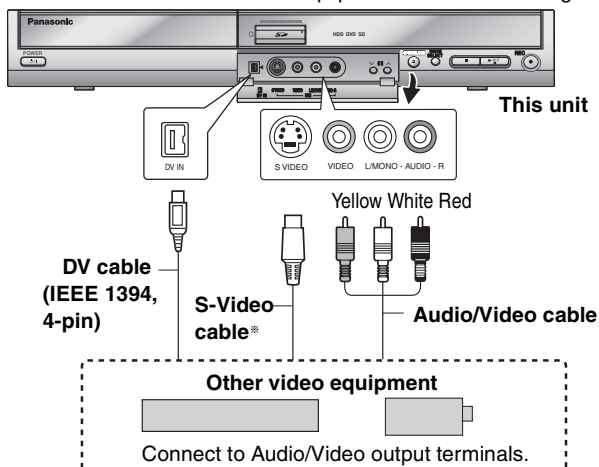

If the audio output of the other equipment is monaural Connect to L/MONO on the IN2 input terminals at the front.

\* The S-VIDEO terminal achieves a more vivid picture than the VIDEO terminal.

## When recording from the unit's DV terminal

Select the type of audio recording from "Select Audio Channel for DV Input" in the SETUP menu (⇒ 56).

When recording from DV equipment (e.g., digital video camcorder), you can record audio/video recordings from DV tape only.

## Manual recording

**HDD** **RAM** **-R** **-RW(V)** **+R**

### Preparation

- Connect a video cassette recorder to this unit's input terminals.
- Press [HDD] or [DVD] to select the recording drive.

### Note

When recording using this unit's input terminals, only the sound received at the time of recording will be recorded. As long as the secondary audio that is recorded on the video cassette is not output on the unit in play, it is not recorded.

- 1 While stopped**  
Press [INPUT SELECT] to select the input channel for the equipment you have connected.  
e.g., If you have connected to IN2 input terminals, select "IN2".

- 2 Press [REC MODE] to select the recording mode.**

- 3 Start play on the other equipment.**

- 4 When you want to start recording**

Press [● REC].

Recording starts.

### To skip unwanted parts

Press [II] to pause recording. (Press again to restart recording.)

### To stop recording

Press [■].

Almost all videos and DVD software on sale have been treated to prevent illegal copying. Any software that has been so treated cannot be recorded using this unit.

- Using Flexible Recording (⇒ 22), you can save the content of a video cassette (approx. 1–8 hours) to a 4.7 GB disc with the best possible quality of recording without wasting disc space.

## DV automatic recording (DV AUTO RECORDING)

### HDD RAM

When the "DV AUTO RECORDING" function is used, programs are recorded as a title. At the same time chapters are created at each break in the images and the playlist is created automatically.

### Preparation

- 1 Turn off the main unit and DV equipment, then connect the DV equipment with the unit's DV input terminal (⇒ left column).
- 2 Turn on the main unit and DV equipment.
- 3 Pause play on the DV equipment at the point you want recording to start.
- 4 Press [HDD] or [DVD] to select the recording drive.

- 1 While stopped**  
Press [FUNCTIONS].
- 2 Press [▲, ▼] to select "Other Functions" and press [ENTER].**
- 3 Press [▲, ▼] to select "DV AUTO RECORDING" and press [ENTER].**
- 4 Press [REC MODE] to select the recording mode.**
- 5 Press [◀, ▶] to select "Rec." and press [ENTER].**  
Recording starts.

### When recording finishes

The confirmation screen appears. Press [ENTER] to finish DV automatic recording.

### To stop recording

Press [■].

### Notes on DV automatic recording

- Only one piece of DV equipment (e.g., digital video camcorder) can be connected to the unit via the DV input terminal.
- If you use video camcorders from other manufacturer's these are not guaranteed to work.
- It is not possible to operate the unit from the connected DV equipment.
- The DV input on this unit is for use with DV equipment only. (It cannot be connected to a computer, etc.)
- The DV equipment name may not be shown correctly.
- Depending on the DV equipment, the images or audio may not be input properly.
- The date and time information on the tape in the DV equipment will not be recorded.
- You cannot record and play simultaneously.

If the DV automatic recording function does not work properly, check the connections and DV equipment settings, and turn the unit off and back on.

If that does not work, follow the instructions for manual recording (⇒ left column).

# Transferring (dubbing) still pictures

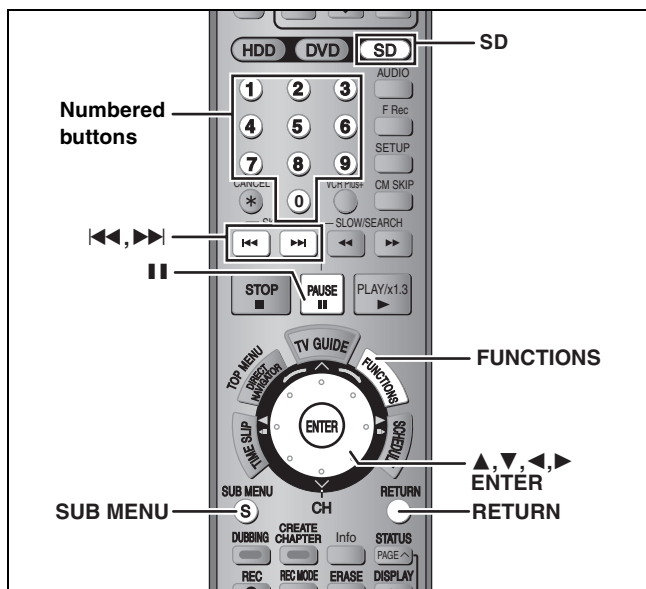

**HDD RAM SD**

- You can use SD Memory Cards with capacities from 8 MB to 1 GB (⇒ 9).

## Transferring (dubbing) using the transferring (dubbing) list

- You cannot transfer (dub) still pictures recorded on CD.

- While stopped  
Press [FUNCTIONS].
- Press [▲, ▼] to select “DUBBING” and press [ENTER].

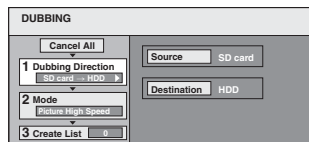

- If you are not going to change the registered list press [▼] several times (⇒ step 6).

- Set the transfer (dubbing) direction.
  - If you are not going to change the dubbing direction, press [▼] (⇒ step 4).
  - Press [▲, ▼] to select “Dubbing Direction” and press [▶].
  - Press [▲, ▼] to select “Source” and press [ENTER].
  - Press [▲, ▼] to select the drive and press [ENTER].
  - Press [▲, ▼] to select “Destination” and press [ENTER].
  - Press [▲, ▼] to select the drive and press [ENTER]. The same drive as the transfer (dubbing) source can be selected.
  - Press [◀] to confirm.
- Set the recording mode.
  - If you are not going to change the recording mode, press [▼] (⇒ step 5).
  - Press [▲, ▼] to select “Mode” and press [▶].
  - Press [▲, ▼] to select “Format” and press [ENTER].
  - Press [▲, ▼] to select “Picture” and press [ENTER]. “Recording Mode” is automatically set to “High Speed”.
  - Press [◀] to confirm.

## 5 Register still pictures for transfer (dubbing).

- If you are going to transfer (dub) a registered list without making any changes to it (⇒ step 6).

You can register still pictures or still picture folders.

- Still pictures and folders cannot be registered on the same list.

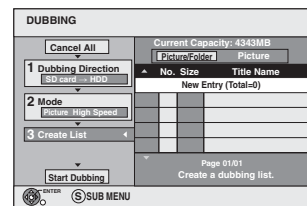

### ■ To register individual still pictures

- Press [▲, ▼] to select “Create List” and press [▶].
- Press [▲, ▼] to select “New Entry” and press [ENTER].
- Press [▲, ▼, ◀, ▶] to select a still picture and press [ENTER].
  - To select a multiple number of items together, press [■] to add the check mark and press [ENTER] (⇒ 49, Multiple editing)
  - To show other pages (⇒ 49)
  - To select the still pictures in another folder (⇒ 49)
  - To edit the transferring (dubbing) list (⇒ 49)

You can register a multiple number of still pictures on the transferring (dubbing) list by repeating steps ②–③.

- Press [◀] to confirm.

### ■ To register on a folder by folder basis

- Press [▲, ▼] to select “Create List” and press [▶].
- Press [▲, ▼] to select “Picture/Folder” and press [ENTER].



- Press [▲, ▼] to select “Folder” and press [ENTER].
- Press [▲, ▼] to select “New Entry” and press [ENTER].
- Press [▲, ▼] to select the folder and press [ENTER].
  - To select a multiple number of items together, press [■] to add the check mark and press [ENTER] (⇒ 49, Multiple editing).
  - To show other pages (⇒ 49)
  - To switch to another higher folder (⇒ 49)
  - To edit the transferring (dubbing) list (⇒ 49)

You can register a multiple number of folders on the transferring (dubbing) list by repeating steps ④–⑤.

- Press [◀] to confirm.

## 6 Press [▲, ▼] to select “Start Dubbing” and press [ENTER].

- For individual still pictures only  
When specifying another folder as the transferring (dubbing) destination, select “Folder”.

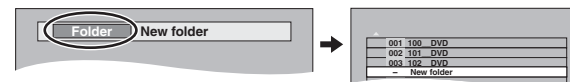

## 7 Press [◀, ▶] to select “Yes” and press [ENTER] to start transferring (dubbing).

### To stop transferring (dubbing)

Press and hold [RETURN] for 3 seconds.

### To return to the previous screen

Press [RETURN].



### To show other pages

Press [▲, ▼, ◀, ▶] to select “Previous” or “Next” and press [ENTER].

- You can also press [◀◀, ▶▶] to show other pages.

### Multiple editing

Select with [▲, ▼, ◀, ▶] and press [III]. (Repeat.)

Press [ENTER] to register to the list.

- A check mark appears. Press [III] again to cancel.

## ■ To edit the transferring (dubbing) list

Select the item in step 5-③ (for a still picture) or 5-⑤ (for a folder) (⇒ 48, right column)

1 Press [SUB MENU].

2 Press [▲, ▼] to select the operation and press [ENTER].

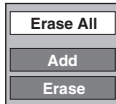

### Erase All:

Erase all items registered on the transferring (dubbing) list.

Press [◀, ▶] to select “Yes” and press [ENTER].

### Add:

Add new items to the transferring (dubbing) list.

Press [▲, ▼, ◀, ▶] to select the still picture or folder to be added and press [ENTER].

### Erase:

Erase the selected items.

Press [◀, ▶] to select “Yes” and press [ENTER].

You can also erase multiple items (⇒ above, Multiple editing).

## To cancel all registered transferring (dubbing) settings and lists

After performing steps 1-2 (⇒ 48, left column)

1 Press [▲, ▼] to select “Cancel All” and press [ENTER].

2 Press [◀, ▶] to select “Yes” and press [ENTER].

- The settings and lists may be cancelled in the following situations.

–When a title or still picture has been recorded or erased at the transfer (dubbing) source

–When steps have been taken, for instance, to turn off the unit, remove the card, open the tray, change the transfer (dubbing) direction, etc.

## ■ To select another folder

(⇒ 9, Structure of folders displayed by this unit)

① Press [▲, ▼, ◀, ▶] to select “Folder” and press [ENTER].

If you want to switch to another higher folder (⇒ below)

② Press [▲, ▼] to select the folder and press [ENTER].



You can also select folders with the numbered buttons.

e.g., 5: [0] ⇒ [0] ⇒ [5]

15: [0] ⇒ [1] ⇒ [5]

115: [1] ⇒ [1] ⇒ [5]

- The still pictures of different folders cannot be registered on the same list.

## To switch to another higher folder

- Only when selecting the source folder

If there is a multiple number of higher folders recognizable,

While the screen on the right appears

1 Press [SUB MENU].

2 Press [▲, ▼] to select “Select Folder” and press [ENTER].

3 Press [◀, ▶] to select the higher folder and press [ENTER].

4 Press [▲, ▼] to select the desired folder and press [ENTER].

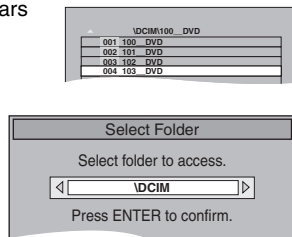

## Transferring (dubbing) all the still pictures on a card—COPY ALL PICTURES

SD → HDD or RAM

### Preparation

Press [SD] to select the source drive.

1

While stopped

Press [FUNCTIONS].

2

Press [▲, ▼] to select “Other Functions” and press [ENTER].

3

Press [▲, ▼] to select “COPY ALL PICTURES” and press [ENTER].

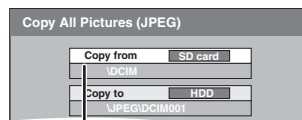

- If there is a multiple number of higher folders recognizable, you can switch them using [◀, ▶].

4

Press [▲, ▼] to select “Copy to” and press [◀, ▶] to select the drive.

5

Press [▲, ▼, ◀, ▶] to select “Copy” and press [ENTER].

### To stop transferring (dubbing)

Press and hold [RETURN] for 3 seconds.

### To return to the previous screen

Press [RETURN].

### Note

- When transferring (dubbing) the still pictures on a folder by folder basis (⇒ 48) or card by card basis (⇒ above, COPY ALL PICTURES), files other than the still picture files inside the folder will also be transferred (dubbed). (This does not apply to the lower folders contained inside the folders.)
- If still pictures are already contained inside the transfer (dubbing) destination folder, the new still pictures are recorded following the existing still pictures.
- If the space on the destination drive runs out or the number of files/folders to be transferred (dubbed) exceeds the maximum (⇒ 35), transferring (dubbing) will stop partway through.
- When a name has not been input for the transfer (dubbing) source folder, it is possible that this folder's name will not be the same on the transfer (dubbing) destination. It is recommended that you input a folder name before transferring (dubbing) (⇒ 42).
- Print number setting (DPOF) is not transferred (dubbed).
- The sequence in which the still pictures are registered on the transfer (dubbing) list may not be the same at the transfer (dubbing) destination.

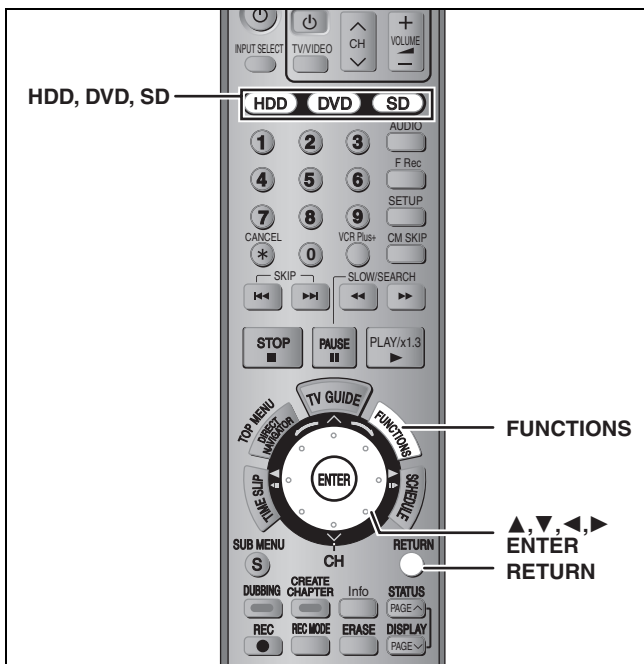

**HDD RAM -R -RW(V) +R -RW(VR) SD**

• You can use SD Memory Cards with capacities from 8 MB to 1 GB (→ 9).

## Common procedures

- 1 While stopped  
Press [FUNCTIONS].
- 2 Press [▲, ▼] to select “Other Functions” and press [ENTER].

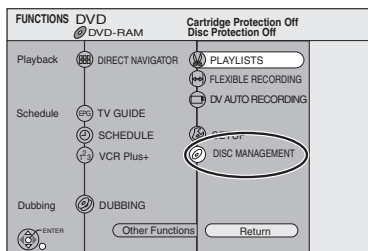

- 3 Press [▲, ▼] to select “DISC MANAGEMENT” or “CARD MANAGEMENT” and press [ENTER].

e.g., **RAM**

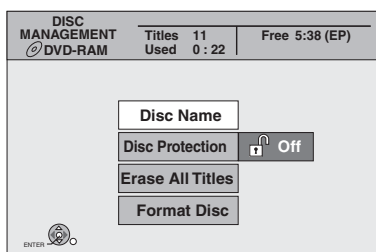

- When HDD has been selected, “Format” and “Erase All Titles” are displayed.
- When SD has been selected, “Format” only is displayed.

## Setting the protection

**RAM**

### Preparation

- Press [DVD] to select the DVD drive.

After performing steps 1–3 (→ left)

- 4 Press [▲, ▼] to select “Disc Protection” and press [ENTER].
- 5 Press [◀, ▶] to select “Yes” and press [ENTER].

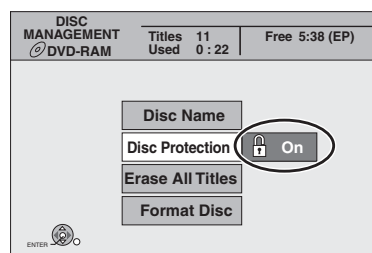

The lock symbol appears closed when the disc is write-protected.

### To return to the previous screen

Press [RETURN].

### To exit the screen

Press [RETURN] several times.

## Cartridge-protection

### For a DVD-RAM with a cartridge

- With the write-protect tab in the protect position, play automatically starts when inserted in the unit.



**SD**

Switch the write-protect switch to the “LOCK” position.



## Providing a name for a disc

**RAM -R -RW(V) +R**

You can provide a name for each disc.

### Preparation

- Press [DVD] to select the DVD drive.
- **RAM** Release protection (→ above).

After performing steps 1–3 (→ left)

- 4 Press [▲, ▼] to select “Disc Name” and press [ENTER].

→ 53, Entering text

- The disc name is displayed in the FUNCTIONS window.
- With a finalized DVD-R, DVD-RW (DVD-Video format) and +R, the name is displayed on the Top Menu.



### To return to the previous screen

Press [RETURN].

### To exit the screen

Press [RETURN] several times.

## Erasing all titles and playlists—Erase All Titles

HDD RAM

### Preparation

- Press [HDD] or [DVD] to select the drive.
- Release protection (⇒ 50).

After performing steps 1–3 (⇒ 50)

**4** Press [**▲**, **▼**] to select “Erase All Titles” and press [ENTER].

**5** Press [**◀**, **▶**] to select “Yes” and press [ENTER].

**6** Press [**◀**, **▶**] to select “Start” and press [ENTER].

A message appears when finished.

**7** Press [ENTER].

---

### To return to the previous screen

Press [RETURN].

### To exit the screen

Press [RETURN] several times.

### Note

- Once erased, the recorded contents are lost and cannot be restored. Make certain before proceeding.
- Erasing all video titles will result in all playlists also being erased.
- Still picture data (JPEG, TIFF) or computer data cannot be erased.
- Erase does not work if one or more titles are protected.

## Erasing all the contents of a disc or card—Format

HDD RAM -RW(V) -RW(VR) SD

### Preparation

- Press [HDD], [DVD] or [SD] to select the drive.
- Release protection (⇒ 50).

### Note

Formatting erases all contents (including computer data), and they cannot be restored. Check carefully before proceeding. The contents are erased when you format a disc or card even if you have set protection.

After performing steps 1–3 (⇒ 50)

**4** Press [**▲**, **▼**] to select “Format” or “Format Disc” and press [ENTER].

**5** Press [**◀**, **▶**] to select “Yes” and press [ENTER].

**6** Press [**◀**, **▶**] to select “Start” and press [ENTER].

A message appears when formatting is finished.

### Note

- Formatting normally takes a few minutes; however, it may take up to a maximum of 70 minutes (RAM).
- Do not disconnect the AC power supply cord while formatting. This can render the disc or the card unusable.

**7** Press [ENTER].

### Note

- When a disc or card has been formatted using this unit, it may not be possible to use it on any other equipment.
- Formatting cannot be performed on DVD-R, +R or CD-R/RW.
- You can format DVD-RW only as DVD-Video format on this unit.

---

### To stop formatting RAM

Press [RETURN].

- You can cancel formatting if it takes more than 2 minutes. The disc must be reformatted if you do this.

### To return to the previous screen

Press [RETURN].

### To exit the screen

Press [RETURN] several times.

Refer to the control reference on page 50.

## Enabling discs to be played on other equipment

(Top Menu Style, Playback will start with:, Finalize)

**-R -RW(V) +R**

### Preparation

Press [DVD] to select the DVD drive.

After performing steps 1–3 (⇒ 50)

### ■ Top Menu Style

You can select the background that will be displayed as the DVD-Video top menu after finalizing.

**4** Press [**▲**, **▼**] to select “Top Menu Style” and press [ENTER].

**5** Press [**▲**, **▼**, **◀**, **▶**] to select the background and press [ENTER].

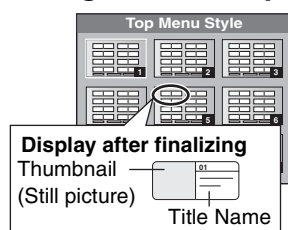

- You can change thumbnails displayed in the top menu. (⇒ 39, Change Thumbnail)

### ■ Playback will start with:

You can select whether to show the top menu after finalizing.

**6** Press [**▲**, **▼**] to select “Playback will start with:” and press [ENTER].

**7** Press [**▲**, **▼**] to select “Top Menu” or “First Title” and press [ENTER].

Top Menu: The top menu appears first.

First Title: The disc content is played without displaying the top menu.

### ■ Finalize

Make selections from “Top Menu Style” and “Playback will start with:” above before finalizing the disc.

**8** Press [**▲**, **▼**] to select “Finalize” and press [ENTER].

**9** Press [**◀**, **▶**] to select “Yes” and press [ENTER].

**10** Press [**◀**, **▶**] to select “Start” and press [ENTER].

A message appears when finalizing is finished.

#### Note

- You cannot cancel finalizing.
- Finalizing takes up to 15 minutes.
- **Do not disconnect the AC power supply cord while finalizing.** This will render the disc unusable.

**11** Press [ENTER].

#### Note

When finalizing a high-speed recording compatible disc, it may take longer than displayed on the confirmation screen (approximately four times).

### After finalizing

- **-R +R** The disc becomes play-only and you can no longer record or edit.
- **-RW(V)** You can record and edit the disc after formatting (⇒ 51) although it becomes play-only after finalizing.
- When transferring (dubbing) in high speed, chapters will be replicated.
- Titles are divided into about 5-minute\* chapters, if
  - the titles were directly recorded to the disc.
  - the titles were transferred (dubbed) using any mode other than the high speed mode.
- \* This time varies greatly depending on the condition and mode of recording.
- There is a pause of several seconds between titles and chapters during play.

#### Note

Chapters on a finalized disc do not appear as thumbnails in the disc's top menu.

	Before finalizing	After finalizing
Disc display on this unit	DVD-R DVD-RW (V) +R	DVD-V
Recording/Editing/Entering name	Yes	No
Play on other players	No	Yes

- You cannot finalize discs recorded on other manufacturer's equipment.
- If you finalize discs recorded on Panasonic equipment other than this unit, the background selected as “Top Menu Style” may not be displayed.
- Discs finalized on this unit may not be playable on other players due to the condition of the recording.
- Visit Panasonic's homepage for more information about DVDs.  
<http://www.panasonic.ca>

#### To return to the previous screen

Press [RETURN].

#### To exit the screen

Press [RETURN] several times.

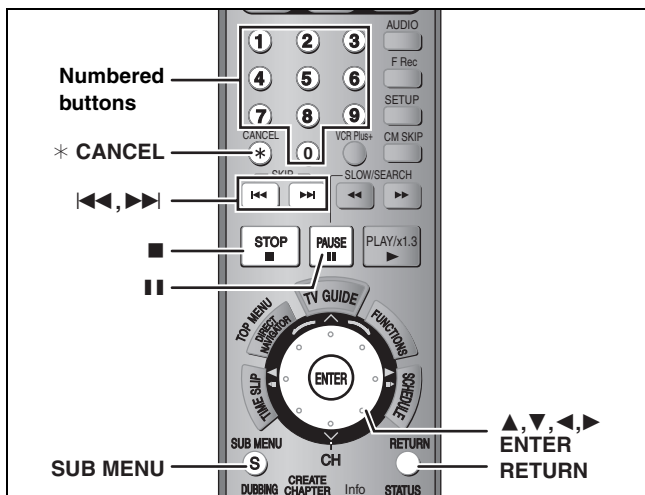

## HDD RAM -R -RW(V) +R SD

You can give names to recorded titles, etc.

The maximum number of characters:

HDD RAM	Characters
Title	64
Playlist	64
Folder of still pictures	36
Disc (RAM)	64

-R -RW(V) +R	Characters
Title	44
Disc	40

SD	Characters
Folder of still pictures	36

### Note

If a name is long, parts of it may not be shown in some screens.

## 1 Show Enter Name screen.

### Title

Select "Title Name" in step 5 on page 38.

### Playlist

Select "Playlist Name" in step 5 on page 41.

### Disc

Select "Disc Name" in step 4 of "Providing a name for a disc" on page 50.

### Folder of still pictures

Select "Folder Name" in step ③ on page 42, "To edit still picture folders".

**Name field:** shows the text you have entered

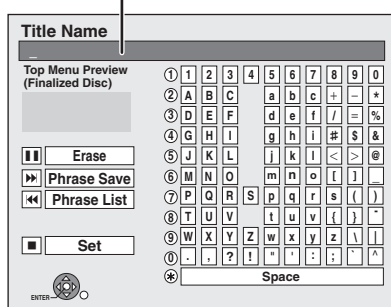

## 2 Press [▲, ▼, ◀, ▶] to select a character and press [ENTER].

Repeat this step to enter other characters.

### •To erase a character

Press [▲, ▼, ◀, ▶] to select the character in the name field and press [■]. (The selected characters are erased.)

### •Using the numbered buttons to enter characters

e.g., entering the letter "R"

- ① Press [7] to move to the 7th row.
- ② Press [7] twice to highlight "R".
- ③ Press [ENTER].

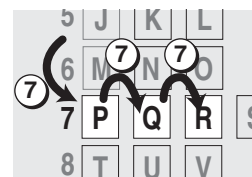

### •To enter a space

Press [\* CANCEL] and press [ENTER].

### •Save/recall phrases (⇒ below)

## 3 Press [■] (Set).

"Now writing." appears then the screen returns to the Title view screen and so on.

### To end partway

Press [RETURN].

Text is not saved.

### ■ To save phrases

You can save frequently used phrases and recall them later.

Maximum number of saved phrases: 20

Maximum number of characters per phrase: 20

After entering the phrase (step1-2)

- 1 Press [▲, ▼, ◀, ▶] to select "Phrase Save" and press [ENTER].

•You can also press [▶▶] to select "Phrase Save".

- 2 Press [◀, ▶] to select "Save" and press [ENTER].

•Press [RETURN] to cancel.

### ■ To recall a saved phrase

- 1 Press [▲, ▼, ◀, ▶] to select "Phrase List" and press [ENTER].

•You can also press [◀◀] to select "Phrase List".

- 2 Press [▲, ▼, ◀, ▶] to select the phrase to be recalled and press [ENTER].

### ■ To erase saved phrases

- 1 Press [▲, ▼, ◀, ▶] to select "Phrase List" and press [ENTER].

•You can also press [◀◀] to select "Phrase List".

- 2 Press [▲, ▼, ◀, ▶] to select the phrase to be erased.

- 3 Press [SUB MENU] to show "Erase Phrase" and press [ENTER].

- 4 Press [◀, ▶] to select "Erase" and press [ENTER].

- 5 Press [RETURN].

### For your reference

If you enter a long name, only part of it is shown in the TOP MENU after finalization (⇒ 52). When entering a title name, the name that will appear in the TOP MENU can be previewed in "Top Menu Preview (Finalized Disc)" window.

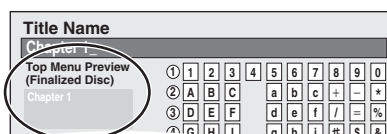

# Changing the unit's settings

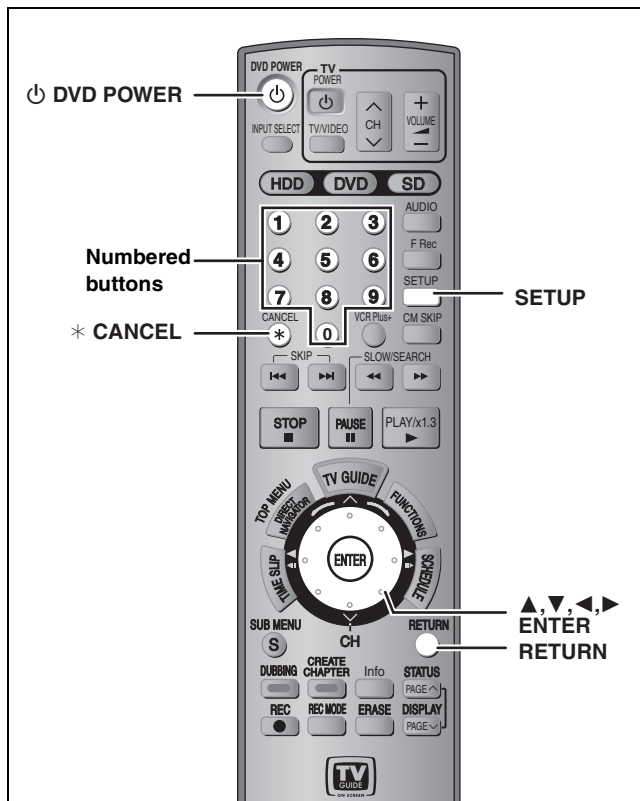

## Common procedures

- 1 While stopped  
Press [SETUP].
- 
- 2 Press [▲, ▼] to select the tab and press [▶].
  - 3 Press [▲, ▼] to select the menu and press [ENTER].
  - 4 Press [▲, ▼] to select the option and press [ENTER].

To return to the previous screen  
Press [RETURN].

To exit the screen  
Press [SETUP].

### Note

There may be differences in operation methods. If this happens, follow the on-screen instructions for the operation.

## Summary of settings

The settings remain intact even if you switch the unit to standby.

Tabs	Menus	Options (Underlined items are the factory presets.)
<b>Channel</b>	<b>TV Guide Settings</b> Set the TV Guide On Screen™ system.	
	<b>Signal Source (RF IN)*2</b> Select to suit the type of antenna you are using.	●Antenna ● <u>CableTV</u>
	<b>Set Channels Automatically*1 (⇒ 57)</b>	—
	<b>Preset Channel Captions*2 (⇒ 58)</b>	—
	<b>Manual Channel Captions*2 (⇒ 58)</b>	—
<b>Setup</b>	<b>Off Timer</b> Select how long the unit remains on when it is not being used.	●2 Hours ● <u>6 Hours</u> ●Off
	<b>Remote Control Code (⇒ 19)</b>	● <u>Set Code 1</u> ●Set Code 2 ●Set Code 3
	<b>Clock Settings</b> Press [ENTER] to show the following settings.	
	<b>Set Clock Automatically*1 (⇒ 57)</b>	
	<b>Set Clock Manually*1 (⇒ 17)</b>	
	<b>Adjust Time Zone*1 (⇒ 57)</b>	●-1 ● <u>0</u> ●+1
	<b>Restore Default Settings</b> This returns all values in the SETUP menus, except for the clock, channel settings, ratings level, and on-screen language, to the default settings.	●Yes ● <u>No</u>

\*1 You need to set these menus only when you do not use TV Guide On Screen™ system. These menus turn gray and become un-selectable after this unit downloads the television program list.

\*2 You can set these menus only after "Set Channels Automatically" is completed.

**Disc**

**Settings for Playback**

Press [ENTER] to show the following settings.

<p><b>Ratings</b> Set a ratings level to limit DVD-Video play.</p> <p>Follow the on-screen instructions. Enter a 4-digit password with the numbered buttons when the password screen is shown.</p> <ul style="list-style-type: none"> <li>Do not forget your password.</li> </ul>	<ul style="list-style-type: none"> <li><u>8 No Limit</u>: All DVD-Video can be played.</li> <li><u>1 to 7</u>: Prohibits play of DVD-Video with corresponding ratings recorded on them.</li> <li><u>0 Lock All</u>: Prohibits play of all DVD-Video.</li> </ul>
<p><b>Play DVD-Audio in Video Mode</b> Select "Video Mode (Video On)" to play DVD-Video content on some DVD-Audio.</p>	<ul style="list-style-type: none"> <li><u>Unlock Recorder</u>      <u>Change Password</u></li> <li><u>Change Level</u>      <u>Temporary Unlock</u></li> </ul>
<p><b>Audio Language</b> Choose the language for audio, subtitle and disc menus. <b>DVD-V</b></p> <ul style="list-style-type: none"> <li>Some discs start in a certain language despite any changes you make here.</li> <li>Enter a code (⇒ 69) with the numbered buttons when you select "Other ****".</li> </ul>	<ul style="list-style-type: none"> <li><u>English</u>      <u>French</u>      <u>Spanish</u></li> <li><u>Original</u>: The original language of each disc will be selected.</li> <li><u>Other ****</u></li> </ul>
<p><b>Subtitle Language</b> When the selected language is not available on the disc, the default language is played. There are discs where you can only switch the language from the menu screen (⇒ 31).</p>	<ul style="list-style-type: none"> <li><u>Automatic</u>: If the language selected for "Audio Language" is not available, subtitles of that language will automatically appear if available on that disc.</li> <li><u>English</u>      <u>French</u>      <u>Spanish</u>      <u>Other ****</u></li> </ul>
<p><b>Menu Language</b></p>	<ul style="list-style-type: none"> <li><u>English</u>      <u>French</u>      <u>Spanish</u>      <u>Other ****</u></li> </ul>

**Settings for Recording**

Press [ENTER] to show the following settings.

<p><b>Recording Time in EP Mode</b> Select the maximum number of hours for recording in EP mode (⇒ 21, Recording modes and approximate recording times).</p>	<ul style="list-style-type: none"> <li><u>EP-Extended Play (6H)</u>: You can record for 6 hours on an unused 4.7 GB disc.</li> <li><u>EP-Extended Play (8H)</u>: You can record for 8 hours on an unused 4.7 GB disc.</li> </ul> <p>The sound quality is better when using "EP-Extended Play (6H)" than when using "EP-Extended Play (8H)".</p>
<p><b>Rec. for High-Speed Dubbing</b> When high speed transferring (dubbing) a title to DVD-R, DVD-RW (DVD-Video format) and +R, it is necessary to turn this setting "On" before recording to HDD; however, the screen size, etc. is restricted (⇒ right). We recommend turning the setting "Off" if high speed transfer (dubbing) to DVD-R, etc. is not necessary when recording a program.</p>	<ul style="list-style-type: none"> <li><u>On</u>: Makes high speed mode transferring (dubbing) to DVD-R, etc. possible. Press [◀, ▶] to select "Yes" and press [ENTER]. ["▶▶▶"] appears in the transferring (dubbing) list (⇒ 45). –Pictures are saved in 4:3. –Select the type of audio in advance from "Select MTS" (⇒ 56).</li> <li><u>Off</u></li> </ul>

**Video**

**Still Mode**

Select the type of picture shown when you pause play (⇒ 68, Frames and fields).

- Automatic
- Field: Select if jittering occurs when "Automatic" is selected. (The picture is coarser.)
- Frame: Select if small text or fine patterns cannot be seen clearly when "Automatic" is selected. (The picture is clearer and finer.)

**Seamless Play**



Select the play mode for playlist chapter segments.

- On: The chapters in playlists are played seamlessly. This does not work when there are several audio types included on the playlist and when using Quick View. Additionally, the positioning of chapter segments may change slightly.
- Off: The points where chapters in playlists change are played accurately, but the picture may freeze for a moment.

**Black Level Control**

Select normal, lighter or darker for adjusting the black level control to the desired setting for picture enhancement.

<p><b>Input Level</b> Adjusts the black level of the input signal.</p>	<ul style="list-style-type: none"> <li><u>Lighter</u>      <u>Darker</u></li> </ul>
<p><b>Output Level (Composite/SVideo)</b> Adjusts the black level of the output signal from the VIDEO OUT and S-VIDEO OUT terminal.</p>	<ul style="list-style-type: none"> <li><u>Lighter</u>      <u>Darker</u></li> </ul>
<p><b>Output Level (Component)</b> Adjusts the black level of the output signal from the COMPONENT VIDEO OUT (Y/P<sub>B</sub>/P<sub>R</sub>) terminals.</p>	<ul style="list-style-type: none"> <li><u>Lighter</u>      <u>Normal</u>      <u>Darker</u></li> </ul>

Tabs	Menus	Options (Underlined items are the factory presets.)
Audio	<b>Dynamic Range Compression</b> <u>DVD-V</u> (Dolby Digital only) Change the dynamic range for late night viewing.	●On      ● <u>Off</u>
	<b>Select MTS</b> Select whether to record the main or secondary (SAP) audio type when: –Recording or transferring (dubbing) to a DVD-R, DVD-RW (DVD-Video format) and +R. –When “Rec. for High-Speed Dubbing” is set to “On” (⇒ 22). –Recording or transferring (dubbing) sound in LPCM. (⇒ below, Audio for XP Recording).	● <u>Main</u> ●Secondary Audio Program (SAP) You cannot select the audio on this unit when recording from an external source, such as when transferring (dubbing) from a video cassette recorder (except from DV equipment connected to this unit's DV input terminal). Select on the other equipment. When recording from the unit's DV terminal, select the type of audio recording from “Select Audio Channel for DV Input” (⇒ below).
	<b>Digital Audio Output</b> Change the settings when you have connected equipment through this unit's DIGITAL AUDIO OUT terminal (⇒ 15). ●Press [ENTER] to show the following settings.	
	<b>PCM Down Conversion</b> Select how to output audio with a sampling frequency of 96 kHz or 88.2 kHz. ●Signals are converted to 48 kHz or 44.1 kHz despite the settings across if the signals have a sampling frequency of over 96 kHz or 88.2 kHz, or the disc has copy protection.	●On: Signals are converted to 48 kHz or 44.1 kHz. (Choose when the connected equipment cannot process signals with sampling frequency of 96 kHz or 88.2 kHz.) ● <u>Off</u> : Signals are output as 96 kHz or 88.2 kHz. (Choose when the connected equipment can process signals with sampling frequency of 96 kHz or 88.2 kHz.)
	<b>Dolby Digital</b>  Select how to output the signal, to output “Bitstream” so the connected equipment decodes the signal, or to decode on this unit and output the signal as “PCM” (2 channel). <b>DTS</b>  <b>Note</b> Not making the proper settings may result in noise, possibly damaging your hearing and speakers, and digital recording may not work properly.	● <u>Bitstream</u> : When connecting to equipment displaying the Dolby Digital logo. ●PCM: When connecting to equipment not displaying the Dolby Digital logo. ● <u>Bitstream</u> : When connecting to equipment displaying the DTS logo. ●PCM: When connecting to equipment not displaying the DTS logo.
<b>Audio for XP Recording</b> Choose the audio type when recording or transferring (dubbing) with XP mode.	● <u>Dolby Digital</u> (⇒ 68) ● <u>LPCM</u> (⇒ 68) –The picture quality of LPCM recordings may be lower than that of normal XP mode recordings. –The audio recording becomes Dolby Digital even if you selected LPCM when using a recording mode other than XP. –When recording a MTS broadcast, select the type of audio in advance from “Select MTS” (⇒ above).	
<b>Select Audio Channel for DV Input</b> You can select the kind of audio when recording from the unit's DV terminal (⇒ 47).	● <u>Stereo 1</u> : Records audio (L1, R1). ●Stereo 2: Records added audio such as narration (L2, R2) subsequent to original recording. ●Mix: Records both Stereo 1 and Stereo 2. When recording a MTS broadcast, to a DVD-R, DVD-RW (DVD-Video format) or +R, or recording in LPCM audio, select the type of audio in advance from “Select MTS” (⇒ above).	
Display	<b>Status Messages</b> Choose whether to show status messages automatically.	● <u>Automatic</u> ●Off
	<b>On-screen Language</b> Choose the language for these menus and on-screen messages.	● <u>English</u> ●Español      ●Français –Only English is displayed in the TV Guide On Screen™ system regardless of the settings. Other languages cannot be displayed.
	<b>Blue Background</b> Select “Off” if you do not want to have the unit show the blue background when reception is weak.	● <u>On</u> ●Off
	<b>Front Display</b> Changes the brightness of the unit's display.	● <u>Bright</u> ●Dim ●Automatic: The display turns dark during play, and reappears momentarily if a button is pressed. When the unit is turned off all displays disappear. While using this mode the standby power consumption can be reduced.
TV Screen	<b>TV Type</b> (⇒ 18) Set to match the type of television connected.	4:3 TV ● <u>Aspect 4:3 &amp; 480i</u> ●Aspect 4:3 & 480p 16:9 Widescreen TV ●Aspect 16:9 & 480i      ●Aspect 16:9 & 480p
	<b>4:3 TV Settings for DVD-Video</b> Select how a DVD-Video widescreen picture is shown on a 4:3 standard aspect television.	● <u>Pan and Scan (Stretch to fit)</u> : Video recorded for a widescreen is played as Pan & Scan (unless prohibited by the producer of the disc). ●Letterbox (Shrink to fit): Video recorded for a widescreen is played in the letterbox style.
	<b>4:3 TV Settings for DVD-RAM</b> Select how a DVD-RAM widescreen picture is shown on a 4:3 standard aspect television.	●4:3: Titles played as recorded. ●Pan and Scan (Stretch to fit): Video recorded for a widescreen is played as Pan & Scan. ● <u>Letterbox (Shrink to fit)</u> : Video recorded for a widescreen is played in the letterbox style.



Refer to the control reference on page 54.

## Preparation:

If the television program list has already been downloaded, return the unit to the factory preset condition using the steps indicated below.

When the unit is on and stopped

- 1 Press and hold [∇ CH] and [∧ CH] on the main unit for about five seconds.

The unit turns off.

- 2 Press [⏻ DVD POWER] to turn the unit on.
- 3 Complete the TV Guide On Screen™ system setup (until [ENTER] is pressed after the “Watch TV” message screen is displayed).

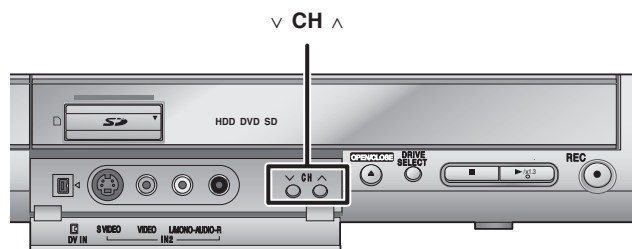

## Note

You can set scheduled recording only manually after you set the unit with “Set Channels Automatically”.

## Auto channel/clock settings

- 1 Press [SETUP].
- 2 Press [▲, ▼] to select “Channel” and press [▶].
- 3 Press [▲, ▼] to select “Set Channels Automatically” and press [ENTER].
- 4 Press [◀, ▶] to select “Yes” and press [ENTER].
- 5 Press [ENTER].

Auto Channel Setting starts. This takes a few minutes. The unit then proceeds with Auto Clock Setting. The time is displayed when finished.

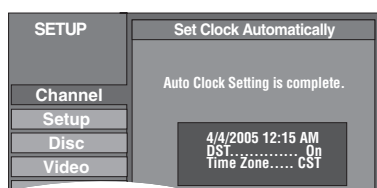

- DST, Daylight Saving Time, shows the summertime setting.
- TIME ZONE shows the time difference from Greenwich Mean Time (GMT).  
 EST (Eastern Standard Time) = GMT -5  
 CST (Central Standard Time) = GMT -6  
 MST (Mountain Standard Time) = GMT -7  
 PST (Pacific Standard Time) = GMT -8  
 AST (Alaska Standard Time) = GMT -9  
 HST (Hawaii Standard Time) = GMT -10  
 For other areas: xx hr
- If the Auto Clock Setting does not start automatically, select “Clock Settings” from the “Setup” tab and then select “Set Clock Automatically”.
- If the time was not set correctly, use manual clock setting (→ 17) or adjust time zone.

- 6 Press [ENTER].

- The unit configures channels according to the Signal Source (RF IN) settings as follows.

Signal Source (RF IN)	Band	Channel
Antenna	VHF	2-13
	UHF	14-69
CableTV	VHF	2-13
	CATV LOW BAND	95-99
	CATV MID/SUPER BAND	14-36
	CATV HYPER BAND	37-65
	ULTRA BAND	66-94 100-125
	SPECIAL CATV CHANNEL	1

## Adjust Time Zone

Adjust the time zone (-1 or +1) if it was not set correctly with auto clock setting.

You cannot change this setting if you set the clock manually.

- 1 Press [SETUP].
- 2 Press [▲, ▼] to select “Setup” and press [▶].
- 3 Press [▲, ▼] to select “Clock Settings” and press [ENTER].
- 4 Press [▲, ▼] to select “Adjust Time Zone” and press [ENTER].

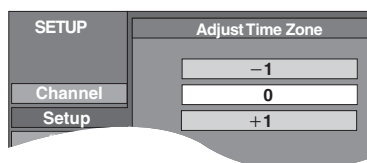

- 5 Press [▲, ▼] to select “-1” or “+1” and press [ENTER].

To return to the previous screen

Press [RETURN].

To exit the screen

Press [SETUP].

To cancel partway while Auto Channel/Clock Setting is taking place

Press [RETURN].

To set so the television program list is not displayed automatically when you turn the unit on

→ 29, “Review Options” menu—Selecting the TV Guide On Screen™ system start up pattern

Refer to the control reference on page 54.

## Channel captions

You can use the preset captions, or manually enter new ones yourself.

The captions you enter are displayed when the channel is displayed and in the Direct Navigator screen.

- You can set channel captions only after “Set Channels Automatically” is completed (➔ 57).

### 1 Press [SETUP].

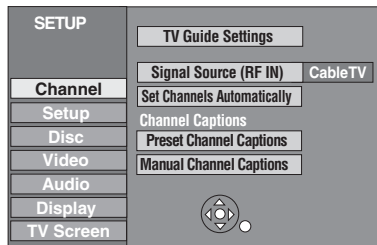

### 2 Press [▲, ▼] to select “Channel” and press [▶].

#### Preset Channel Captions

### 3 Press [▲, ▼] to select “Preset Channel Captions” and press [ENTER].

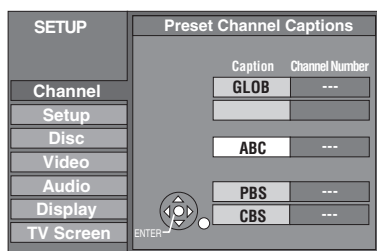

### 4 Press [▲, ▼] to select the caption and press [▶].

You can choose from the following captions.

ABC, PBS, CBS, CNN, FOX, ESPN, NBC, HBO, A&E, AMC, FAM, MAX, MTV, SHOW, TBS, USA, TNT, CBC, UPN, CTV, WB, TSN, DSC, GLOB

- When selecting the caption, press and hold [▲, ▼] to scroll up and down the screen.

### 5 Press [▲, ▼] to select the channel corresponding to the caption and press [◀].

- Channels are only displayed if they contain a station and if captions have not been added manually.
- To delete the channel number, press [\* CANCEL].

Repeat steps 4 and 5 to enter other channels.

### 6 Press [ENTER].

#### Manual Channel Captions

### 3 Press [▲, ▼] to select “Manual Channel Captions” and press [ENTER].

### 4 Press [▲, ▼] to select the channel and press [▶].

- Channels are only displayed if they contain a station and if preset captions have not been added.

### 5 Press [▲, ▼] to select the first character and press [▶].

- You can choose from the following characters:  
A–Z, 0–9, -, &, !, /, (space)
- To delete the caption, press [\* CANCEL].
- Repeat this step to enter the other characters.

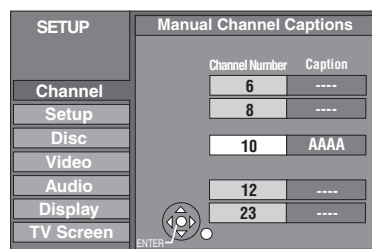

### 6 Press [◀, ▶] to return to the “Channel Number” column.

Repeat steps 4–6 to enter other channels.

### 7 Press [ENTER].

To return to the previous screen

Press [RETURN].

To exit the screen





Press [SETUP].

## On the television

		Page
Cannot finish recording completely.	<ul style="list-style-type: none"> <li>The program was copy-protected.</li> <li>The HDD or disc may be full.</li> <li>The maximum number of times you can record the program is exceeded.</li> </ul>	—
Cannot play.	<ul style="list-style-type: none"> <li>You inserted an incompatible disc (Discs recorded in PAL video, etc.).</li> </ul>	—
Cannot record on the disc.	<ul style="list-style-type: none"> <li>The disc may be dirty or scratched.</li> </ul>	5
Unable to format.		
Please check the disc.		
Cannot play back on this DVD-Recorder.	<ul style="list-style-type: none"> <li>You tried to play a non-compatible image.</li> <li>Turn the unit off and re-insert the card.</li> </ul>	35 5
Cannot record. Disc is full.	<ul style="list-style-type: none"> <li><b>HDD RAM</b> Create space by erasing any unnecessary titles. [Even if you erase recorded content from the DVD-R or +R, there is no increase in disc space. Available disc space on DVD-RW (DVD-Video format) increases only when the last recorded title is erased.]</li> <li>Use a new disc.</li> </ul>	32, 39, 51
Cannot record. The number of titles has exceeded the maximum limit.		
Error has occurred. Please press ENTER.	<ul style="list-style-type: none"> <li>Press [ENTER] to start recovery process. You cannot operate the unit while it is recovering ("SELF CHECK" appears on the unit's display).</li> </ul>	—
No disc	<ul style="list-style-type: none"> <li>The disc may be upside down.</li> </ul>	—
No folders.	<ul style="list-style-type: none"> <li>There is no compatible folder in this unit.</li> </ul>	9
No SD Card No valid SD card.	<ul style="list-style-type: none"> <li>The card is not inserted. If this message is displayed with a compatible card already inserted, turn off the unit, remove and then re-insert the card.</li> <li>The card inserted is not compatible or the card format does not match.</li> </ul>	5 9
There is not enough free space on dubbing destination.	<ul style="list-style-type: none"> <li>Create space by erasing any unnecessary items.</li> <li>Erase one or more items registered on the transfer (dubbing) list to ensure that the "Current capacity" is not exceeded.</li> </ul>	32, 35, 39, 42, 51 45, 49
Please change the disc.	<ul style="list-style-type: none"> <li>There may be a problem with the disc. Press [<b>▲</b> OPEN/CLOSE] on the main unit to remove it and check it for scratches or dirt. (The unit turns off automatically after you open the tray.)</li> </ul>	5
This is a non-recordable disc.	<ul style="list-style-type: none"> <li>The unit cannot record on the disc you inserted. Insert a DVD-RAM or unfinalized DVD-R, DVD-RW (DVD-Video format) or +R.</li> <li>You inserted an unformatted DVD-RAM or DVD-RW.</li> </ul>	8, 9
This disc is not formatted properly.		
		

## On the unit's display

The following messages or service numbers appear on the unit's display when something unusual is detected during startup and use.

<b>CHK REMOTE</b> □ ("□" stands for a number.)	<ul style="list-style-type: none"> <li>The remote control and main unit are using different codes. Change the code on the remote control.</li> </ul>  <p>Press and hold [ENTER] and the indicated number button at the same time for more than 2 seconds.</p>	19
<b>HARD ERR</b>	<ul style="list-style-type: none"> <li>If there is no change after turning the unit on and off, consult the dealer where the unit was purchased.</li> </ul>	—
<b>HDD SLP</b>	<ul style="list-style-type: none"> <li>In order to extend HDD life, the HDD is in SLEEP mode. Press [HDD] to activate.</li> </ul>	4
<b>NO READ</b>	<ul style="list-style-type: none"> <li>The disc is dirty or badly scratched. The unit cannot record, play, or edit.</li> <li>You have used a DVD lens cleaner and it has finished. Press [<b>▲</b> OPEN/CLOSE] on the main unit to eject the disc.</li> </ul>	5 5
<b>PLEASE WAIT</b>	<ul style="list-style-type: none"> <li>Displayed when the unit is started. This is not a malfunction.</li> <li>The unit is carrying out its recovery process. You cannot operate the unit while "PLEASE WAIT" is displayed.</li> </ul>	— —
<b>SELF CHECK</b>	<ul style="list-style-type: none"> <li>There was something unusual detected with the disc while recording, playing or transferring(dubbing), there was a power failure or the AC plug was disconnected while the unit was on. The unit is carrying out its recovery process. This process restores the unit to normal operation. The unit is not broken. Wait until the message disappears.</li> </ul>	62
<b>UNFORMAT</b>	<ul style="list-style-type: none"> <li>You inserted an unformatted DVD-RAM or a DVD-RW that is unformatted or recorded on other equipment.</li> </ul>	—
<b>UNSUPPORT</b>	<ul style="list-style-type: none"> <li>You have inserted a disc the unit cannot play or record on.</li> </ul>	8, 9
<b>U59</b>	<ul style="list-style-type: none"> <li>The unit is hot. The unit switches to standby for safety reasons. Wait for about 30 minutes until the message disappears. Select a position with good ventilation when installing the unit. Do not block the cooling fan on the rear of the unit.</li> </ul>	—
<b>U99</b>	<ul style="list-style-type: none"> <li>The unit fails to operate properly. Press [POWER /I] on the main unit to switch the unit to standby. Now press [POWER /I] on the main unit again to turn the unit on.</li> </ul>	—
<b>H□□ or F□□</b>	<ul style="list-style-type: none"> <li>There is something unusual. (The service number displayed after H and F depends on the unit's condition.)</li> <li>Check the unit using the troubleshooting guide. If the service number does not disappear, do the following.                             <ol style="list-style-type: none"> <li>Disconnect the plug from the AC outlet, wait a few seconds, then reconnect it.</li> <li>Press [POWER /I] to turn the power on. (The unit may be fixed.)</li> </ol>                             If the service number does not disappear despite doing the above, request service from the dealer. Inform the dealer of the service number when requesting service.                         </li> </ul>	— 62–66
<b>R□□:□□</b> (e.g., R44:00)	<ul style="list-style-type: none"> <li>The unit is showing you the remaining time on the HDD or the disc. (This does not indicate a malfunction.) In the display across the letter "R" means "Remain" and the numbers mean remaining time (hours:minutes).</li> </ul>	20

# Frequently asked questions

Refer to the following items if you have any doubts about unit operations.

Set up		Page
What equipment is necessary to play multi channel surround sound?	<ul style="list-style-type: none"> <li>● DVD-Video: You can play DVD-Video multi channel surround by digitally connecting an amplifier equipped with a Dolby Digital and a DTS decoder.</li> <li>● DVD-Audio: This unit plays DVD-Audio in 2 channels. You cannot play multi channel surround sound.</li> </ul>	15 —
Are the headphones and speakers directly connected to the unit?	<ul style="list-style-type: none"> <li>● You cannot directly connect them to the unit. Connect through the amplifier, etc.</li> </ul>	15
Is my television progressive output compatible?	<ul style="list-style-type: none"> <li>● All Panasonic televisions that have 480p input terminals are compatible. Consult the manufacturer if you have another brand of television.</li> </ul>	—
The television has both S VIDEO IN terminal and COMPONENT VIDEO IN terminals. Which should I connect with?	<ul style="list-style-type: none"> <li>● We recommend the COMPONENT VIDEO IN terminal. Component signal outputs the color difference signals (P<sub>B</sub>/P<sub>R</sub>) and luminance signal (Y) separately in order to achieve high fidelity in reproducing colors. If the television is compatible with progressive output, a high quality picture can be output because this unit's component video output terminal outputs a progressive output signal.</li> </ul>	14
Disc		
Can I play DVD-Video, DVD-Audio and Video CDs bought in another country?	<ul style="list-style-type: none"> <li>● You can play them if the video standard is NTSC.</li> <li>● However, you cannot play DVD-Video if their region number does not include "1" or "ALL". Refer to the disc's jacket for more information.</li> </ul>	— <b>Cover</b>
Can a DVD-Video that does not have a region number be played?	<ul style="list-style-type: none"> <li>● The DVD-Video region number indicates the disc conforms to a standard. You cannot play discs that do not have a region number. You also cannot play discs that do not conform to a standard.</li> </ul>	—
Please tell me about DVD-R, DVD-RW, +R and +RW compatibility with this unit.	<ul style="list-style-type: none"> <li>● This unit records and plays DVD-R, DVD-RW (DVD-Video format) and +R, and plays DVD-RW (DVD Video Recording format) and +RW.</li> <li>● This unit also records and plays high speed recording compatible DVD-R, DVD-RW, +R discs.</li> </ul>	8, 9 —
Please tell me about CD-R and CD-RW compatibility with this unit.	<ul style="list-style-type: none"> <li>● This unit plays CD-R/CD-RW discs which have been recorded in one of the following standards: CD-DA, Video CD, MP3 and still pictures (JPEG/TIFF). Close the session or finalize the disc after recording. This unit can recognize up to 99 folders (groups) and 999 files (tracks) on a disc with MP3 or still pictures (JPEG/TIFF).</li> <li>● You cannot write to a CD-R or CD-RW with this unit.</li> </ul>	9, 33, 35 —
Recording		
Can I record from a commercially purchased video cassette or DVD?	<ul style="list-style-type: none"> <li>● Most commercially sold video cassettes and DVD are copy protected; therefore, recording is usually not possible.</li> </ul>	—
Can DVD-R, DVD-RW (DVD-Video format) and +R recorded on this unit be played on other equipment?	<ul style="list-style-type: none"> <li>● You can play on compatible equipment such as DVD players after finalizing the disc on this unit. However, depending on the condition of the recording, the quality of the disc and capabilities of the DVD player, play may not be possible.</li> </ul>	—
Can I record digital audio signals using this unit?	<ul style="list-style-type: none"> <li>● You cannot record digital signals. The digital audio terminals on this unit are for output only. (The audio recorded from a digital video camcorder using the DV automatic recording function, for example, is recorded digitally.)</li> </ul>	—
Can a digital audio signal from this unit be recorded to other equipment?	<ul style="list-style-type: none"> <li>● You can record if using the PCM signal. When recording DVD, change the "Digital Audio Output" settings to the following from the SETUP menu.                      —PCM Down Conversion    On                      —Dolby Digital            PCM                      —DTS                        PCM                      However, only                      —As long as digital recording from the disc is permitted.                      —As long as the recording equipment is compatible with a sampling frequency of 48 kHz.</li> <li>● You cannot record MP3 signals.</li> </ul>	56 —
Can I switch to SAP during recording?	<ul style="list-style-type: none"> <li>● With HDD and DVD-RAM, you can, and the audio recorded also changes. Just press [AUDIO].</li> <li>● With DVD-R, DVD-RW (DVD-Video format), +R you cannot. Change before recording with "Select MTS" in the SETUP menu.</li> </ul>	22 56
Can I high speed transfer (dub) to a disc?	<ul style="list-style-type: none"> <li>● When using a high speed recording compatible disc, you can transfer (dub) a one hour program to:                      —DVD-R or +R in approximately 56 seconds*                      —DVD-RAM in approximately 1.5 minutes*                      —DVD-RW (DVD-Video format) in approximately 1.9 minutes*                      * Quickest possible time.</li> </ul>	43

Does the TV Guide On Screen™ system work with analog and digital cable TV boxes?	<ul style="list-style-type: none"> <li>• Yes. The TV Guide On Screen™ system works with both analog and digital cable TV boxes.</li> </ul>	—
I have relocated, changed my television reception system or cable TV box etc. How should I redo the TV Guide On Screen™ system setup?	<ul style="list-style-type: none"> <li>• Select “Change system settings” in “SETUP” in the Navigation menu of the TV Guide On Screen™ system. If you select “No, repeat setup process”, you can then access the TV Guide On Screen™ system setup screen. You can also access the setup screen from “TV Guide Settings” in the SETUP menu.</li> </ul>	29, 54
Please tell me about the downloading of television program list data.	<ul style="list-style-type: none"> <li>• Channel line-up data is transmitted continuously, 24 hours a day—7 days a week.</li> <li>• Program information that contains details about each program is usually transmitted four times a day, and the cycles last approximately 3 hours. The TV Guide On Screen™ system only requires one transmission a day to maintain up-to-date program listings. Because the unit must be turned off in order to receive new information, multiple transmissions are conveniently scheduled early to mid-morning and during the early afternoon hours.</li> </ul>	— —
Why doesn't my favorite program have more information in the information window or expanded information window?	<ul style="list-style-type: none"> <li>• The hardware that makes TV Guide On Screen™ system possible is a computer chip which has limited storage space. Factors used in determining which programs display detailed program information are the number of channels turned “ON” in the CHANNEL EDITOR screen and the availability of the descriptions. Setting channels that cannot be received to “OFF” in the CHANNEL EDITOR screen may increase the amount of information displayed.</li> </ul>	29
What kind of information might be seen in the MESSAGES screen?	<ul style="list-style-type: none"> <li>• Useful Product Related Information (PRI) such as alerting the user to new features or data available through the TV Guide On Screen™ system. This feature may not be active in all viewing areas.</li> </ul>	—
Can I record one channel while watching another?	<p>If you do not connect a cable TV box</p> <ul style="list-style-type: none"> <li>• Yes. Change the television's input mode to “TV”.</li> </ul> <p>If you connect a cable TV box</p> <ul style="list-style-type: none"> <li>• No. The user cannot watch one program and record another.</li> </ul>	— —
If I have a power failure, will I need to reset the scheduled recording of programs I have already set?	<ul style="list-style-type: none"> <li>• In most cases the scheduled recording of programs will be saved. However, if an extended power failure occurs, it is strongly recommended that you verify the scheduled recording of programs that you had previously set. Press [SCHEDULE] to display the SCHEDULE screen.</li> </ul>	27
I do not want TV Guide On Screen™ system to automatically appear on screen.	<ul style="list-style-type: none"> <li>• Select “Off” in “Review options” menu, so that TV Guide On Screen™ system appears only when you press [TV GUIDE].</li> </ul>	29
I do not want to use TV Guide On Screen™ system.	<ul style="list-style-type: none"> <li>• Set the unit with “Set Channels Automatically” in the SETUP menu. Note that you can set scheduled recording only manually after you set the unit with “Set Channels Automatically”.</li> </ul>	57

# Troubleshooting guide

Before requesting service, make the following checks. If you are in doubt about some of the check points, or if the solutions indicated in the chart do not solve the problem, refer to the “Product information” on page 69.

## The following do not indicate a problem with this unit:

- Regular disc rotating sounds.
- Poor reception due to atmospheric conditions.
- Image disturbance during search.
- Interruptions in reception due to periodic satellite broadcasting breaks.
- A sound is heard when the HDD goes into SLEEP mode, or operations are slow to respond in SLEEP mode.
- Operations do not work due to a poor-quality disc. (Try again using a Panasonic disc.)
- The unit freezes due to one of its safety devices being activated. (Press and hold [POWER ⏻/I] on the main unit for 10 seconds.)
- When the HDD has been automatically placed in the SLEEP mode (➡ 4), or the unit is turned on or off, there may be an unexpected sound. This does not indicate a problem with this unit.

## To reset this unit

		Page
<b>To return the channel settings and clock to the factory preset (No setting)</b>	● Press and hold [CH ▲] and [▼ CH] on the main unit for about 5 seconds. (Current channel line-up and television program list are cleared.)	—
<b>To return all the settings other than the main ones to the factory preset</b>	● Select “Yes” in “Restore Default Settings” in the SETUP menu. This returns all values in the SETUP menus, except for the clock, channel settings, ratings level, and on-screen language, to the default settings.	54
<b>To reset the ratings level settings</b>	● While the disc tray is open, press [DVD] then press and hold [● REC] and [▶] (PLAY/× 1.3) on the main unit at the same time for 5 or more seconds.	—
<b>To restore the unit if it freezes due to one of the safety devices being activated</b>	● Press and hold [POWER ⏻/I] on the main unit for 10 seconds. (The settings remain.)	—

## Power

<b>No power.</b>	● Insert the AC power supply cord securely into a known active AC outlet.	12, 13
<b>The unit switches to standby mode.</b>	<ul style="list-style-type: none"> <li>● This is a power saving feature. It can be changed if desired using “Off Timer” in the SETUP menu.</li> <li>● One of the unit’s safety devices is activated. Press [POWER ⏻/I] on the main unit to turn the unit on.</li> </ul>	54 —

## Displays

<b>The display is dim.</b>	● Change “Front Display” in the SETUP menu.	56
<b>“12:00A” is flashing on the unit’s display.</b>	<ul style="list-style-type: none"> <li>● After setting the TV Guide On Screen™ system, wait until the clock is downloaded. (The flashing “12:00A” will change to the current time.)</li> <li>● If the unit’s display does not change to the current time even after waiting, we recommend that you set the clock using “Set Clock Manually”.</li> <li>● If you do not want to use the TV Guide On Screen™ system, set the clock with “Set Clock Automatically”.</li> </ul>	— 17 57
<b>Compared to the actual recorded time, the elapsed time displayed is less.</b>	● The displayed recording/play time is converted from the number of frames at 29.97 frames (equal to 0.999 seconds) to one second. There will be a slight difference between the time displayed and the actual elapsed time (e.g., actual one-hour elapsed time may display as approximately 59 minutes 56 seconds). This does not affect the recording.	—
<b>The time recorded on the disc and the available time shown do not add up.</b>	● Times shown may disagree with actual times.	—
<b>The play time shown for MP3 does not agree with the actual time.</b>	<ul style="list-style-type: none"> <li>● Available recording space on DVD-RW (DVD-Video format) increases only when the last recorded title is erased. It does not increase if other titles are erased.</li> <li>● Even if you erase recorded content from the DVD-R or +R, there is no increase in disc space.</li> <li>● More disc space than the actual recording time is used after recording or editing the DVD-R or +R 200 times or more.</li> <li>● While searching, the elapsed time may not display correctly.</li> </ul>	— — — —
<b>“SELF CHECK” is displayed and the disc cannot be ejected.</b>	<ul style="list-style-type: none"> <li>● The unit is carrying out the recovery process. Do the following to eject the disc.                             <ol style="list-style-type: none"> <li>1 Press [POWER ⏻/I] on the main unit to switch the unit to standby. If the unit doesn’t switch to standby, press and hold [POWER ⏻/I] on the main unit for about 10 seconds. The unit is forcibly switched to standby.</li> <li>2 While the unit is off, press and hold [■] and [CH ▲] on the main unit at the same time for about 5 seconds. Remove the disc.</li> </ol> </li> </ul>	—

## TV screen and video

<b>Television reception worsens after connecting the unit.</b>	● This can occur because the signals are being divided between the unit and other equipment. It can be solved by using a signal booster, available from audio-visual suppliers. If it is not solved by using a signal booster, consult the dealer.	—
<b>Status messages do not appear.</b>	● Select “Automatic” in “Status Messages” in the SETUP menu.	56
<b>The blue background does not appear.</b>	● Select “On” in “Blue Background” in the SETUP menu.	56
<b>The 4:3 aspect ratio picture expands left and right.</b>	● Use the television to change the aspect. If your television does not have that function, set “Progressive” in the Video menu to “Off”.	37
<b>Screen size is wrong.</b>	● Check the settings for “TV Type”, “4:3 TV Settings for DVD-Video” or “4:3 TV Settings for DVD-RAM” in the SETUP menu.	56
<b>There is a lot of after-image when playing video.</b>	● Change the settings for “Integrated DNR” to “0” or turn “MPEG-DNR” off if it is on.	37
<b>When playing DVD-Video using progressive output, one part of the picture momentarily appears to be doubled up.</b>	● Set “Progressive” in the Video menu to “Off”. This problem is caused by the editing method or material used on DVD-Video, but should be corrected if you use interlace output.	37

TV screen and video (Continued)

		Page
There is no apparent change in picture quality when adjusted with the Video menu in the on-screen menus.	<ul style="list-style-type: none"> <li>The effect is less perceivable with some types of video.</li> </ul>	—
The images from this unit do not appear on the television.	<ul style="list-style-type: none"> <li>Make sure that the television is connected to the VIDEO OUT terminal, S VIDEO OUT terminal or COMPONENT VIDEO OUT terminals on this unit.</li> <li>Make sure that the television's input setting (e.g., VIDEO 1) is correct.</li> </ul>	12–14
Picture is distorted.	<ul style="list-style-type: none"> <li>Progressive output is set to on but the connected television is not progressive compatible. Press and hold [■] and [▶] (PLAY/×1.3) on the main unit at the same time for more than 5 seconds to cancel this setting. The setting will change to interlace.</li> </ul>	—
The channels keep changing.	<ul style="list-style-type: none"> <li>When the unit is turned off, it uses the IR Blaster to scan the cable TV box channels and acquire the TV program list data. To watch a cable TV box program (even if not recording) turn the unit back on.</li> </ul>	—

Sound

No sound. Low volume. Distorted sound. Cannot hear the desired audio type.	<ul style="list-style-type: none"> <li>Check the connections and the “Digital Audio Output” settings. Check the input mode on the amplifier if you have connected one.</li> <li>Press [AUDIO] to select the audio.</li> <li>Turn off V.S.S. in the following cases.                             <ul style="list-style-type: none"> <li>When using discs that do not have surround sound effects such as Karaoke discs.</li> <li>When playing MTS broadcast programs.</li> </ul> </li> <li>The disc may have a restriction on the method of audio output. If “D.MIX” does not appear in the display when playing multi-channel DVD-Audio, only audio for the two front channels will be output. Refer to the disc's jacket. <b>DVD-A</b></li> </ul>	12–15, 56 22, 32 37
Cannot switch audio.	<ul style="list-style-type: none"> <li>You cannot switch the audio in the following cases.                             <ul style="list-style-type: none"> <li>When a DVD-R, DVD-RW (DVD-Video format) or +R disc is in the disc tray while DVD drive is selected.</li> <li>When the recording mode is XP and “Audio for XP Recording” is set to “LPCM”.</li> <li>When “Rec. for High-Speed Dubbing” is set to “On”.</li> </ul> </li> <li>When connecting an amplifier using an optical digital cable, you cannot switch the audio if “Dolby Digital” is set to “Bitstream”. Set “Dolby Digital” to “PCM” or connect using audio cables.</li> <li>There are discs for which audio cannot be changed because of how the disc was created.</li> </ul>	—  56 22 56, 15 —

Operation

Cannot operate the television. The remote control doesn't work.	<ul style="list-style-type: none"> <li>Change the manufacturer code. Some televisions cannot be operated even if you change the code.</li> <li>The remote control and main unit are using different codes. Change the code on the remote control. Press and hold [ENTER] and the indicated number button at the same time for more than 2 seconds.</li> </ul> 	19 19	
	<ul style="list-style-type: none"> <li>The batteries are depleted. Replace them with new ones.</li> <li>You are not pointing the remote control at the main unit's remote control signal sensor during operation.</li> <li>Colored glass may obstruct the signal reception/transmission.</li> <li>Don't place the signal sensor in direct sunlight or in areas that may be subject to sunlight exposure.</li> <li>It may be necessary to set the code on the remote control again after changing the batteries.</li> <li>It may be necessary to set the manufacturer code again after changing the batteries.</li> </ul>	7 — — — 19 19	
	<ul style="list-style-type: none"> <li>Recording drive or playback drive has not been selected properly.</li> <li>Some operations may be prohibited by the disc.</li> <li>The unit is hot (“U59” appears on the display). Wait for “U59” to disappear.</li> <li>One of the unit's safety devices may have been activated. Reset the unit as follows:                             <ol style="list-style-type: none"> <li>Press [POWER ⏻/⏪] on the main unit to switch the unit to standby. If the unit doesn't switch to standby, press and hold [POWER ⏻/⏪] on the main unit for about 10 seconds. The unit is forcibly switched to standby. Alternatively, disconnect the AC power supply cord, wait one minute, then reconnect it.</li> <li>Press [POWER ⏻/⏪] on the main unit to switch it on. If the unit still cannot be operated, consult the dealer.</li> </ol> </li> </ul>	20, 30 — — —	
	HDD activation is slow.	<ul style="list-style-type: none"> <li>The HDD is in SLEEP mode. (“HDD SLP” appears in the unit's display.)</li> </ul>	4
	Cannot eject disc.	<ul style="list-style-type: none"> <li>The unit is recording.</li> <li>The unit may have a problem. While the unit is off, press and hold [■] and [CH ^] on the main unit at the same time for about 5 seconds. Remove the disc and consult the dealer.</li> </ul>	— —
Startup is slow.	<ul style="list-style-type: none"> <li>Startup takes time in the following situations.                             <ul style="list-style-type: none"> <li>A disc other than a DVD-RAM is inserted.</li> <li>The clock is not set.</li> <li>Immediately after a power failure or the AC power supply cord is connected.</li> </ul> </li> </ul>	—	
Takes time to read DVD-RAM.	<ul style="list-style-type: none"> <li>It may take time to read a disc if it is being used for the first time in this unit or it has not been used for a long time.</li> </ul>	—	

Continued on next page

Recording/Scheduled recording/Transferring (dubbing)

		Page
<b>Cannot record.</b>	● You haven't inserted a disc or the disc you inserted cannot be recorded on. Insert a disc the unit can record onto.	8, 9
	● The disc is unformatted. Format the disc. <b>RAM -RW(V)</b>	51
	● The write-protect tab on the cartridge is set to PROTECT, or the disc is protected with DISC MANAGEMENT.	50
	● Some programs have limitations on the number of times they can be recorded. (CPRM)	68
	● You cannot record when there is not enough space or when the number of titles has reached its limit. Erase unwanted titles or use a new disc.	32, 39, 51
	● You cannot record on finalized DVD-R, DVD-RW (DVD-Video format), +R or DVD-RW (DVD Video Recording format) discs.	—
	● Due to peculiarities of DVD-R, DVD-RW (DVD-Video format) and +R, you may be unable to record onto them if you either insert and remove the disc or switch the unit on and off while a disc is loaded, a total of fifty times.	—
● A DVD-R, DVD-RW (DVD-Video format) and +R recorded on this unit may not be recordable on other Panasonic DVD Recorders.	—	
<b>Cannot record from external equipment.</b>	● Check that the connection is correct.	12-15, 47
	● Select the input channel ("IN1", "IN2", "IN3" or "DV") for the equipment you have connected .	—
<b>Scheduled recording does not work properly.</b>	● The scheduled program is incorrect or different scheduled program times overlap. Correct the program.	27
<b>VCR Plus+ system does not work properly.</b>	● The scheduled program may be deleted if there is an interruption to the power.	—
	● VCR Plus+ system works only after this unit downloads the television program list.	—
<b>Scheduled recording does not stop even when [■] is pressed.</b>	● Press [■] and then [ENTER] within 5 seconds. Recording stops.	—
<b>The scheduled program remains even after recording finishes.</b>	● The scheduled program remains unless set to "Once".	24, 25
<b>A part or whole of a recorded title has been lost.</b>	● If there is a power failure or the plug is disconnected from the household AC outlet while recording or editing, the title may be lost or the HDD/disc may become unusable. You will have to format the disc ( <b>HDD RAM -RW(V)</b> ) or use a new disc. We cannot offer any guarantee regarding lost titles or discs.	51
<b>The program name and the recorded title do not match.</b>	● There was a program change after scheduled recording was set but the recorded title still has the old program name.	—
<b>Cannot transfer (dub) to a DVD-R, etc. disc using the high speed mode.</b>	● When recording to the HDD, set "Rec. for High-Speed Dubbing" to "On" in the SETUP menu.	22
<b>When transferring (dubbing), it takes a long time even when high speed mode is selected.</b>	● Use a disc that is compatible with high speed recording. Even if the disc is high speed recording compatible, the maximum speed may not be possible due to the condition of the disc.	—
	● It takes longer than normal to transfer (dub) many titles.	—
	● You cannot high speed transfer (dub) to DVD-R, DVD-RW (DVD-Video format) and +R, titles longer than 6 hours when using other Panasonic DVD Recorders that are not compatible with EP (8 hour) mode recording.	—
<b>An unusually loud sound is coming from the rotating DVD-R, etc.</b>	● When recording or high speed transferring (dubbing) to a DVD-R, DVD-RW (DVD-Video format) and +R, the sound of the disc rotating may be louder than normal; however, this is not a problem.	—
<b>The DV automatic recording function does not work.</b>	● If images cannot be recorded or if the recording is aborted, check the connections and DV equipment settings.	47
	● You cannot start recording until the images from the DV equipment appear on the television.	—
	● Recording may not be performed as desired if the time codes on the tape in the DV equipment are not successive.	—
	● Depending on the equipment, the DV automatic recording may not operate properly.	—
	● You can only record audio/video images on a DV tape.	—
<b>There is no picture on the television during scheduled recording.</b>	● Scheduled recordings are activated regardless of whether the unit is turned on/off. Turn on the power to confirm the contents of the scheduled recording.	—

TV Guide On Screen™ system

<b>Although initial setup for the TV Guide On Screen™ system was completed hours ago, television program list does not display when [TV GUIDE] is pressed.</b>	● Leave the unit turned off for at least 24 hours.	—
	● Initial setup was done incorrectly. (e.g. The user entered the wrong country, postal code or cable TV box information.) Select "Change system settings" menu and verify the data entered during initial setup. If the settings are wrong, set up the TV Guide On Screen™ system again.	29
	● Check the connection and set up the TV Guide On Screen™ system again.	29
	If you connect a cable TV box	
	–the output terminal of the cable TV box is connected to this unit's RF IN or IN3 terminal	13
	–the IR Blaster is correctly connected and installed	13
	–the cable TV box is turned on	—
	If you do not connect a cable TV box	
	–the antenna cable is connected to this unit's RF IN terminal	12
	● The television program list was temporarily unavailable in your area (Wait another 24 hours or Redo setup).	—
● The television program list is not available in your area. Set the unit using "Set Channels Automatically". Note that you can only manually set scheduled recording after you set the unit using "Set Channels Automatically".	57	
● Consult your service provider if you are using a cable TV box.	—	
● The TV Guide On Screen™ system may not be able to receive the program list data if reception is poor. This may be improved by using a booster. Consult your dealer.	—	
<b>"Cable code -INCOMPLETE-" appears in the TV Guide On Screen™ system setup.</b>	● The unit cannot find the correct IR code for the cable TV box. Consult your service provider.	—



<p><b>As soon as the unit is turned on, and when you try to start scheduled recording, the TV Guide On Screen™ system setup begins.</b></p>	<ul style="list-style-type: none"> <li>● Even if you do not want to use the TV Guide On Screen™ system, you need to complete the TV Guide On Screen™ system setup (until you have to press [ENTER] after the “Watch TV” message screen is displayed). It will not be displayed after this point.</li> </ul>	<p>16</p>
<p><b>Some or all of the channels display “No Listing”</b></p>	<ul style="list-style-type: none"> <li>● For a newly installed unit, the TV Guide On Screen™ system may not have been given enough time to download the initial data. This procedure can only occur when the unit is in standby mode for a period of 24 hours. (During this time, do not turn on the unit as the download will be interrupted.) Once the procedure takes place the phrase “No Listing” will be replaced with program information.</li> <li>● The channel(s) in question was (were) recently turned “ON” (in the CHANNEL EDITOR screen); however, TV Guide On Screen™ system has yet to receive channel data for this channel. Leave the unit in standby mode.</li> <li>● Immediately after beginning use there are several days of blank listings. You can display the television program list for up to the next 8 days without any blank listings by downloading program lists continuously over several days.</li> <li>● The unit was left turned on for an extended period of time and the TV Guide On Screen™ system was unable to receive television program list data. Press [⏻ DVD POWER] to set the unit in standby mode when not in use.</li> <li>● During the data download the station from which data is downloaded had an unscheduled power outage.</li> <li>● If using an off-air antenna, marginally poor reception can cause some of the data to be missed.</li> <li>● If using a cable TV box, it was accidentally turned off. In installations using a cable TV box, the box must be left on continuously.</li> </ul>	<p>—</p> <p>—</p> <p>—</p> <p>—</p> <p>—</p> <p>—</p> <p>—</p>
<p><b>Cannot receive some channels displayed on the television program list.</b></p>	<ul style="list-style-type: none"> <li>● Cable TV subscribers receive channel data for all available channels your cable TV provider offers. In order to view all the channels, you’d also have to subscribe to all the channels. If you are connected to an off-air antenna the channel data you receive often represents a viewing area larger than you would typically be able to receive. Your location, the type of TV antenna you are using and your distance from each station’s transmitting antenna will all determine which channels are viewable from your location. Once you’ve determined which channels can be received, all others can be removed from the television program list. Set these channels to “OFF” in the CHANNEL EDITOR screen.</li> </ul>	<p>29</p>
<p><b>Some off-air or cable channels are not listed on the television program list and even on the CHANNEL EDITOR screen.</b></p>	<ul style="list-style-type: none"> <li>● Presently, the TV Guide On Screen™ system does not list all channels in any given broadcast area. As a result, channels are selected primarily on a “majority rules” basis. Channels with the highest potential viewership are given top priority.</li> <li>● Data for local programming which is not provided to TV Guide’s data distribution network would also not be available.</li> </ul>	<p>—</p> <p>—</p>
<p><b>The program highlighted doesn’t match up with the video window on the TV screen.</b></p>	<ul style="list-style-type: none"> <li>● The data entered during the initial setup was incorrect or the channel line-up you selected was incorrect. Select “Change system settings” menu and verify the data entered during initial setup. If the settings are wrong, set up the TV Guide On Screen™ system again.</li> <li>● The station in question may have made recent program schedule changes and the TV Guide On Screen™ system has not yet been updated.</li> </ul>	<p>29</p> <p>—</p>
<p><b>The unit doesn’t change channels or it changes to the wrong channel.</b></p>	<ul style="list-style-type: none"> <li>● Data entered into the initial setup screen was done incorrectly. (e.g., The user entered the wrong postal code or selected the incorrect channel line-up.) Select “Change system settings” menu and verify the data entered during initial setup. If the settings are wrong, set up the TV Guide On Screen™ system again.</li> </ul>	<p>29</p>
<p><b>Some channels are listed on the wrong number.</b></p>	<ul style="list-style-type: none"> <li>● The cable company has not yet informed industry sources of their channel line-up changes. Use the CHANNEL EDITOR feature to make adjustments.</li> </ul>	<p>29</p>
<p><b>Two stations are received on certain channels; morning and evening programs differ.</b></p>	<ul style="list-style-type: none"> <li>● Such situations occur more frequently on cable TV. “Split” channels occur when the cable provider may not have an adequate number of open channels and chooses to switch the channel line to better suit the subscribers’ viewing habits. When a “Split” channel occurs, program data for only one channel is usually provided.</li> </ul>	<p>—</p>
<p><b>Cable TV box doesn’t change channels with TV Guide On Screen™ system.</b></p>	<ul style="list-style-type: none"> <li>● The incorrect cable TV box brand code was selected during the initial setup. Select “Change system settings” menu and verify the data entered during initial setup. If the setting is wrong, set up the TV Guide On Screen™ system again.</li> <li>● The user has incorrectly connected or positioned the IR Blaster. Please reconnect or reposition it.</li> <li>● The cable TV box has no remote capability and is incompatible. Consult your service provider.</li> <li>● The user has an “after market” brand cable TV box which may be incompatible. Consult your service provider.</li> </ul>	<p>29</p> <p>13</p> <p>—</p> <p>—</p>
<p><b>Cannot record a program. The screen remains snowy or blue.</b></p>	<p>If you do not connect a cable TV box</p> <ul style="list-style-type: none"> <li>● The unit was not hooked up correctly. Please reconnect it.</li> <li>● The user selected the incorrect channel lineup. Select “Change system settings” menu and verify the data entered during initial setup. If the setting is wrong, set up the TV Guide On Screen™ system again.</li> </ul> <p>If you connect a cable TV box</p> <ul style="list-style-type: none"> <li>● The unit is not set to the correct output channel. Select “Change system settings” menu and verify the data entered during initial setup. If the setting is wrong, redo setup correctly choosing 03, 04 or whichever output channel is set by your cable system.</li> <li>● The unit and/or cable TV box is hooked up incorrectly. Please reconnect it, or contact the cable company for proper wiring procedure.</li> <li>● The cable TV box was left OFF. The user should always leave the cable TV box turned on and the unit turned off (when not in use).</li> </ul>	<p>12</p> <p>29</p> <p>29</p> <p>13</p> <p>—</p>
<p><b>The SCHEDULE screen only shows the channel number of the program instead of the program name.</b></p>	<ul style="list-style-type: none"> <li>● The time slot and channel for the scheduled program may not have yet received listings information. Once updated information is received the program name will appear in the SCHEDULE screen.</li> </ul>	<p>—</p>

Play		Page	
<b>Play fails to start even when [▶] (PLAY) is pressed.</b> <b>Play starts but then stops immediately.</b>	<ul style="list-style-type: none"> <li>● Insert the disc correctly with the label facing up.</li> <li>● The disc is dirty.</li> <li>● You tried to play a blank disc or disc unplayable on this unit.</li> <li>● You tried to play a +RW that needs to be finalized on the equipment used for recording.</li> <li>● You may be able to transfer (dub) a "One time only recording" title that was recorded to DVD-RAM using a different Panasonic DVD Recorder to this unit's HDD, but play is not possible due to copyright protection.</li> <li>● When recording to DVD-RAM using EP (8H) mode, play may not be possible on DVD players that are compatible with DVD-RAM. In this case use EP (6H) mode.</li> <li>● You cannot play discs during DV automatic recording.</li> </ul>	<p>30 5 8, 9 — — 55 —</p>	
	<b>Audio and video momentarily pause.</b>	<ul style="list-style-type: none"> <li>● This occurs between playlist chapters.</li> <li>● This occurs between chapters and with partially deleted titles on finalized DVD-R, DVD-RW (DVD-Video format) and +R that have been transferred (dubbed) using the high speed mode.</li> <li>● This occurs as scenes change during Quick View.</li> </ul>	— — —
	<b>DVD-Video is not played.</b>	<ul style="list-style-type: none"> <li>● You have set a ratings level to limit DVD-Video play. Change this setting.</li> </ul>	55
	<b>Alternative soundtrack and subtitles cannot be selected.</b>	<ul style="list-style-type: none"> <li>● The languages are not recorded on the disc.</li> <li>● You may not be able to use the on-screen menus to change the soundtrack and subtitles on some discs. Use the disc's menus to make changes.</li> </ul>	— 31
	<b>No subtitles.</b>	<ul style="list-style-type: none"> <li>● When progressive output is on, closed captions cannot be displayed.</li> <li>● Subtitles are not recorded on the disc.</li> <li>● Turn the subtitles on. Set "Subtitle" on the on-screen menu to "On".</li> </ul>	— — 36
<b>Angle cannot be changed.</b>	<ul style="list-style-type: none"> <li>● Angles can only be changed during scenes where different angles are recorded.</li> </ul>	—	
<b>You have forgotten your ratings password.</b> <b>You want to cancel the ratings level.</b>	<ul style="list-style-type: none"> <li>● The ratings level returns to the factory preset. While the disc tray is open, press [DVD] then press and hold [● REC] and [▶] (PLAY) on the main unit at the same time for 5 or more seconds ("INIT" will appear on the unit's display).</li> </ul>	—	
<b>Quick View does not work.</b>	<ul style="list-style-type: none"> <li>● This does not work when audio is other than Dolby Digital.</li> <li>● <b>HDD RAM</b> This does not work when recording is in XP or FR mode.</li> </ul>	— —	
<b>The resume play function does not work.</b>	<ul style="list-style-type: none"> <li>● This function only works when "PLAY" is flashing on the unit display.</li> <li>● Memorized positions are canceled when the unit is turned off or when the tray is opened. The memorized position on the playlist is also canceled when the playlist and title are edited.</li> </ul>	— —	

Edit		Page
<b>Cannot format.</b>	<ul style="list-style-type: none"> <li>● The disc is dirty. Wipe with a damp cloth and then wipe dry.</li> <li>● You tried formatting a disc that you may not be able to use in this unit.</li> </ul>	5 8, 9
<b>Cannot create chapters.</b>	<ul style="list-style-type: none"> <li>● The unit writes the chapter division information to the disc when you turn it off or remove the disc. The information is not written if there is an interruption to the power before this.</li> </ul>	—
<b>Cannot mark the start point or the end point during "Shorten Title" operation.</b>	<ul style="list-style-type: none"> <li>● These operations are not possible with still pictures.</li> <li>● You cannot set points if they are too close to each other. You cannot set an end point before a start point.</li> </ul>	— —
<b>Cannot erase chapters.</b>	<ul style="list-style-type: none"> <li>● When the chapter is too short to erase, use "Combine Chapters" to make the chapter longer.</li> </ul>	39
<b>The available recording time doesn't increase even after erasing recordings on the disc.</b>	<ul style="list-style-type: none"> <li>● Available recording space on the DVD-R and +R does not increase even after erasing previously recorded titles.</li> <li>● Disc space on a DVD-RW (DVD-Video format) increases only when the last recorded title is erased. It does not increase if other titles are erased.</li> </ul>	— —
<b>Cannot create a playlist.</b>	<ul style="list-style-type: none"> <li>● You cannot select all the chapters at once in a title if the title also includes still pictures. Select them individually.</li> </ul>	—

Still pictures		Page
<b>Cannot display Direct Navigator screen.</b>	<ul style="list-style-type: none"> <li>● This screen cannot be displayed during recording or transfer (dubbing).</li> </ul>	—
<b>Cannot edit or format a card.</b>	<ul style="list-style-type: none"> <li>● Release the card's protection setting. (With some cards, the "Write Protection Off" message sometimes appears on the screen even when protection has been set.)</li> </ul>	50
<b>The contents of the card cannot be read.</b>	<ul style="list-style-type: none"> <li>● The card format is not compatible with the unit. (The contents on the card may be damaged.) Format using FAT 12 or FAT 16 with other equipment or format the card with this unit.</li> </ul>	9, 35, 51
	<ul style="list-style-type: none"> <li>● The card contains a folder structure and/or file extensions that are not compatible with this unit.</li> </ul>	9
	<ul style="list-style-type: none"> <li>● Turn off and then turn on the unit again.</li> </ul>	—
<b>Transferring (dubbing), erasing and setting protection takes a long time.</b>	<ul style="list-style-type: none"> <li>● When there are a lot of folders and files, it may sometimes take a few hours.</li> <li>● When repeating transferring (dubbing) or erasing, it may sometimes take a long time. Format the disc or card.</li> </ul>	— 51
<b>Scheduled recording began in the middle of editing a still picture.</b>	<ul style="list-style-type: none"> <li>● If it comes to the time scheduled for recording, the recording may start even though you are editing.</li> </ul>	—

# Specifications

## Recordable discs:

DVD-RAM:	Ver. 2.0 Ver. 2.1/3×-SPEED DVD-RAM Revision 1.0 Ver. 2.2/5×-SPEED DVD-RAM Revision 2.0
DVD-R:	For General Ver. 2.0 For General Ver. 2.0/4×-SPEED DVD-R Revision 1.0 For General Ver. 2.x/8×-SPEED DVD-R Revision 3.0
DVD-RW:	Ver. 1.1 Ver. 1.1/2×-SPEED DVD-RW Revision 1.0 Ver. 1.2/4×-SPEED DVD-RW Revision 2.0
+R:	Ver. 1.0 Ver. 1.1 Ver. 1.2

## Recording system:

DVD-RAM:	DVD Video Recording format
DVD-R:	DVD-Video format
DVD-RW:	DVD-Video format

**Internal HDD Capacity:** 200 GB

## Recording time:

- Maximum 8 hours (using 4.7 GB disc)
  - XP: Approx. 1 hour    SP: Approx. 2 hours
  - LP: Approx. 4 hours    EP: Approx. 6 hours or 8 hours
- Maximum approx. 355 hours with 200 GB HDD (EP 8H mode)
  - XP: Approx. 44 hours    SP: Approx. 89 hours
  - LP: Approx. 177 hours    EP: Approx. 266 hours or 355 hours

## Playable discs:

DVD-RAM	DVD-R
DVD-RW	+R
+RW	
DVD-Video	DVD-Audio
CD-Audio (CD-DA)	Video CD
CD-R/CD-RW (CD-DA, Video CD, MP3, JPEG formatted discs)	

## Optical pick-up:

System with 1 lens, 2 integration units  
(662 nm wavelength for DVDs, 795 nm wavelength for CDs)

## LASER Specification

Class I LASER Product	
Wave Length:	795 nm (CDs) 662 nm (DVDs)
Laser Power:	No hazardous radiation is emitted with the safety protection

## Television system

TV system:	NTSC system, 525 lines, 60 fields	
Antenna reception	TV Channel:	2 ch-69 ch
input:	CATV Channel:	1 ch-125 ch
RF converter output:	Not provided	

## Video system

<b>Recording system:</b>	MPEG2 (Hybrid VBR)	
<b>Input:</b>	LINE (pin jack) ×3, 1.0 Vp-p; 75 Ω	S connector ×3    Y:1.0 Vp-p; 75 Ω C: 0.286 Vp-p; 75 Ω
<b>Output:</b>	LINE (pin jack) ×2, 1.0 Vp-p; 75 Ω	S connector ×2    Y:1.0 Vp-p; 75 Ω C: 0.286 Vp-p; 75 Ω
<b>Component video output:</b>	Y, P <sub>B</sub> , P <sub>R</sub> ×1 (480p/480i)	Y: 1.0 Vp-p; 75 Ω P <sub>B</sub> : 0.7 Vp-p; 75 Ω P <sub>R</sub> : 0.7 Vp-p; 75 Ω

## Audio system

<b>Recording system:</b>	Dolby Digital (2ch), Linear PCM (XP mode 2ch)	
<b>Analog Input:</b>	LINE (pin jack) ×3	Reference input: 309 mVrms FS: 2 Vrms (1 kHz, 0 dB) Input impedance: 47 kΩ
<b>Analog Output:</b>	LINE (pin jack) ×2	Reference output: 309 mVrms FS: 2 Vrms (1 kHz, 0 dB) Output impedance: 1 kΩ (Load impedance: 10 kΩ)
<b>Number of channels:</b>	Recording: 2 channels Playback: 2 channels	
<b>Digital Output:</b>	Digital audio optical output connector ×1 (PCM, Dolby Digital, DTS)	

## SD Card Slot

<b>Still Picture (JPEG, TIFF)</b>	SD Memory Card Slot: 1 pc
<b>Compatible media</b>	SD Memory Card*, MultiMediaCard * Includes miniSD™ cards. (A miniSD™ adaptor needs to be inserted.)
<b>Format</b>	FAT12, FAT16
<b>Image file format:</b>	JPEG conforming to DCF (Design rule for Camera File system) TIFF (Uncompressed RGB chunky), DPOF Compatible Sub sampling; 4:2:2 or 4:2:0
<b>Number of pixels:</b>	between 34 × 34 and 6144 × 4096 pixels
<b>Thawing time:</b>	Approx. 7 sec (2 M pixels)

<b>SD Card Slot:</b>	1 pc
<b>DV input:</b>	IEEE 1394 Standard, 4 Pin: 1 pc
<b>G-LINK Terminal:</b>	only use the included IR Blaster
<b>Regional Code:</b>	# 1
<b>Clock unit:</b>	Quartz-controlled 12-hour digital display
<b>Operating temperature range:</b>	5 °C to 40 °C (41 °F to 104 °F)
<b>Operating humidity range:</b>	10 % to 80 % RH (no condensation)
<b>Power supply:</b>	AC 120 V, 60 Hz
<b>Power consumption:</b>	Approx. 31 W
<b>Dimensions (W×H×D):</b>	Approx. 430 mm×63 mm×350.5 mm (Approx. 16 <sup>15</sup> / <sub>16</sub> "×2 <sup>1</sup> / <sub>2</sub> "×13 <sup>13</sup> / <sub>16</sub> "

**Mass:** Approx. 4.5 kg (9.92 lbs)

**Power consumption in standby mode:** approx. 13.7 W

## Note

Specifications are subject to change without notice.  
Mass and dimensions are approximate.

- Useable capacity will be less (SD Memory Card).

## User memo:

DATE OF PURCHASE \_\_\_\_\_  
DEALER NAME \_\_\_\_\_  
DEALER ADDRESS \_\_\_\_\_  
\_\_\_\_\_  
TELEPHONE NUMBER \_\_\_\_\_

The model number and serial number of this product can be found on either the back or the bottom of the unit. Please note them in the space provided below and keep for future reference.

MODEL NUMBER \_\_\_\_\_ DMR-EH60 \_\_\_\_\_  
SERIAL NUMBER \_\_\_\_\_

## Bitstream

This is the digital form of multi-channel audio data (e.g., 5.1 channel) before it is decoded into its various channels.

## CPRM (Content Protection for Recordable Media)

CPRM is technology used to protect broadcasts that are allowed to be recorded only once. Such broadcasts can be recorded only with CPRM compatible recorders and discs.

## Decoder

A decoder restores the coded audio signals on DVDs to normal. This is called decoding.

## Dolby Digital

This is a method of coding digital signals developed by Dolby Laboratories. Apart from stereo (2-channel) audio, these signals can also be multi-channel audio. A large amount of audio information can be recorded on one disc using this method.

When recording on this unit Dolby Digital (2 channel) is the default audio.

## Down-mixing

This is the process of remixing the multi-channel audio found on some discs into two channels. It is useful when you want to listen to the 5.1-channel audio recorded on DVDs through your television's speakers. Some discs prohibit down-mixing and this unit can then only output the front two channels.

## DPOF (Digital Print Order Format)

DPOF is the standard printing format for still picture data taken by a digital camera, etc. It is used for automatic printing at a photo developing store or on your home printer.

## Drive

In the instance of this unit, this refers to the hard disk (HDD), disc (DVD) and SD card (SD). These perform the reading and writing of data.

## DTS (Digital Theater Systems)

This surround system is used in many movie theaters. There is good separation between the channels, so realistic sound effects are possible.

## Dynamic range

Dynamic range is the difference between the lowest level of sound that can be heard above the noise of the equipment and the highest level of sound before distortion occurs.

Dynamic range compression means reducing the gap between the loudest and softest sounds. This means you can listen at low volumes but still hear dialog clearly.

## EPG (Electronic Program Guide)

This is a system used to display the television program list on televisions, computers and cellular phones. Data is transmitted using the internet or television waves. This unit is compatible with the method using television waves. You can use the television program list for functions such as scheduled recording.

## Film and video

DVD-Video are recorded using either film or video. This unit can determine which type has been used, then uses the most suitable method of progressive output.

Film is 24 or 30 frames per second, with motion picture film generally being 24 frames per second.

Video is 60 fields per second (two fields making up one frame).

## Finalize

A process that makes play of a recorded CD-R, CD-RW, DVD-R, etc. possible on equipment that can play such media. You can finalize DVD-R, DVD-RW (DVD-Video format) and +R on this unit.

After finalizing, the disc becomes play-only and you can no longer record or edit. However, finalized DVD-RW can be formatted to become recordable.

## Folder

This is a place on the hard disk or memory card where groups of data are stored together. In the case of this unit, it refers to the place where still pictures (JPEG, TIFF) are stored.

## Formatting

Formatting is the process of making media such as DVD-RAM recordable on recording equipment.

You can format the HDD, DVD-RAM, DVD-RW (only as DVD-Video format) and SD memory card on this unit. Formatting irrevocably erases all contents.

## Frames and fields

Frames refer to the single images that constitute the video you see on your television. Each frame consists of two fields.



Frame

Field

Field

- A frame still shows two fields, so there may be some blurring, but picture quality is generally better.
- A field still shows less picture information so it may be rougher, but there is no blurring.

## HDD (Hard disk drive)

This is a mass data storage device used in computers, etc. A disk with a surface that has been treated with magnetic fluid is spun and a magnetic head is brought in close proximity to facilitate the reading and writing of large amounts of data at high speed.

## JPEG (Joint Photographic Experts Group)

This is a system used for compressing/decoding color still pictures. If you select JPEG as the storage system on digital cameras, etc., the data will be compressed to 1/10–1/100 of its original size. The benefit of JPEG is less deterioration in picture quality considering the degree of compression.

## LPCM (Linear PCM)

These are uncompressed digital signals, similar to those found on CDs. LPCM sound is available when recording in XP mode.

## MP3 (MPEG Audio Layer 3)

An audio compression method that compresses audio to approximately one tenth of its size without any considerable loss of audio quality. You can play MP3 you have recorded onto CD-R and CD-RW.

## Pan&Scan/Letterbox

In general, DVD-Video are produced with the intention that they be viewed on a widescreen television (16:9 aspect ratio), so images often don't fit regular (4:3 aspect ratio) televisions. Two styles of picture, "Pan & Scan" and "Letterbox", deal with this problem.

Pan&Scan: The sides are cut off so the picture fills the screen.



Letterbox: Black bands appear at the top and bottom of the picture so the picture itself appears in an aspect ratio of 16:9.



## Playback control (PBC)

If a Video CD has playback control, you can select scenes and information with menus.

(This unit is compatible with version 2.0 and 1.1.)

## Progressive/Interlace

NTSC, the video signal standard, has 480 interlaced (i) scan lines, whereas progressive scanning uses twice the number of scan lines. This is called 480p.

Using progressive output, you can enjoy the high-resolution video recorded on media such as DVD-Video.

Your television must be compatible to enjoy progressive video.

## Protection

You can prevent accidental erasure by setting writing protection or erasure protection.

## Sampling frequency

Sampling is the process of converting the heights of sound wave (analog signal) samples taken at set periods into digits (digital encoding). Sampling frequency is the number of samples taken per second, so larger numbers mean more faithful reproduction of the original sound.

## Thumbnail

This refers to a miniature representation of a picture used to display multiple pictures in the form of a list.

## TIFF (Tag Image File Format)

This is a system used for compressing/decoding color still pictures, a common format for storing high quality images on digital cameras and other devices.

## Language code list

Enter the code with the numbered buttons.

Abkhazian: 6566	Catalan: 6765	Gujarati: 7185	Lingala: 7678	Rhaeto-Romance: 8277	Tamil: 8465
Afar: 6565	Chinese: 9072	Hausa: 7265	Lithuanian: 7684	Romanian: 8279	Tatar: 8484
Afrikaans: 6570	Corsican: 6779	Hebrew: 7387	Macedonian: 7775	Russian: 8285	Telugu: 8469
Albanian: 8381	Croatian: 7282	Hindi: 7273	Malagasy: 7771	Samoan: 8377	Thai: 8472
Ameharic: 6577	Czech: 6783	Hungarian: 7285	Malay: 7783	Sanskrit: 8365	Tibetan: 6679
Arabic: 6582	Danish: 6865	Icelandic: 7383	Malayalam: 7776	Scots Gaelic: 7168	Tigrinya: 8473
Armenian: 7289	Dutch: 7876	Indonesian: 7378	Maltese: 7784	Serbian: 8382	Tonga: 8479
Assamese: 6583	English: 6978	Interlingua: 7365	Maori: 7773	Serbo-Croatian: 8372	Turkish: 8482
Aymara: 6589	Esperanto: 6979	Irish: 7165	Marathi: 7782	Shona: 8378	Turkmen: 8475
Azerbaijani: 6590	Estonian: 6984	Italian: 7384	Moldavian: 7779	Sindhi: 8368	Twi: 8487
Bashkir: 6665	Faroese: 7079	Japanese: 7465	Mongolian: 7778	Singhalese: 8373	Ukrainian: 8575
Basque: 6985	Fiji: 7074	Javanese: 7487	Nauru: 7865	Slovak: 8375	Urdu: 8582
Bengali; Bangla: 6678	Finnish: 7073	Kannada: 7578	Nepali: 7869	Slovenian: 8376	Uzbek: 8590
Bhutani: 6890	French: 7082	Kashmiri: 7583	Norwegian: 7879	Somali: 8379	Vietnamese: 8673
Bihari: 6672	Frisian: 7089	Kazakh: 7575	Oriya: 7982	Spanish: 6983	Volapük: 8679
Breton: 6682	Galician: 7176	Kirghiz: 7589	Pashto, Pushto: 8083	Sundanese: 8385	Welsh: 6789
Bulgarian: 6671	Georgian: 7565	Korean: 7579	Persian: 7065	Swahili: 8387	Wolof: 8779
Burmese: 7789	German: 6869	Kurdish: 7585	Polish: 8076	Swedish: 8386	Xhosa: 8872
Byelorussian: 6669	Greek: 6976	Laotian: 7679	Portuguese: 8084	Tagalog: 8476	Yiddish: 7473
Cambodian: 7577	Greenlandic: 7576	Latin: 7665	Punjabi: 8065	Tajik: 8471	Yoruba: 8979
	Guarani: 7178	Latvian, Lettish: 7686	Quechua: 8185	Zulu: 9085	

## Product Service

- 1. Damage requiring service**—The unit should be serviced by qualified service personnel if:
  - (a) The AC power supply cord or AC adaptor has been damaged; or
  - (b) Objects or liquids have gotten into the unit; or
  - (c) The unit has been exposed to rain; or
  - (d) The unit does not operate normally or exhibits a marked change in performance; or
  - (e) The unit has been dropped or the cabinet damaged.
- 2. Servicing**—Do not attempt to service the unit beyond that described in these operating instructions. Refer all other servicing to authorized servicing personnel.
- 3. Replacement parts**—When parts need replacing ensure the servicer uses parts specified by the manufacturer or parts that have the same characteristics as the original parts. Unauthorized substitutes may result in fire, electric shock, or other hazards.
- 4. Safety check**—After repairs or service, ask the servicer to perform safety checks to confirm that the unit is in proper working condition.

## Product information

For product information or assistance with product operation:

Contact the Panasonic Canada Inc. Customer Care Centre at 1-800-561-5505, or visit the website ([www.panasonic.ca](http://www.panasonic.ca)), or an authorized Servicentre closest to you.

Panasonic Canada Inc.

## PANASONIC/TECHNICS PRODUCT—LIMITED WARRANTY

Panasonic Canada Inc. warrants this product to be free from defects in material and workmanship and agrees to remedy any such defect for a period as stated below from the date of original purchase.

<b>Technics Audio Product</b>	<b>One (1) year, parts and labour</b>
<b>Panasonic Audio &amp; DVD Product</b>	<b>One (1) year, parts and labour</b>
<b>Accessories including rechargeable batteries</b>	<b>Ninety (90) days</b>

In-home Service will be carried out only to locations accessible by roads and within 50 km of an authorized Panasonic service facility.

### **LIMITATIONS AND EXCLUSIONS**

This warranty does not apply to products purchased outside Canada or to any product which has been improperly installed, subjected to usage for which the product was not designed, misused or abused, damaged during shipping, or which has been altered or repaired in any way that affects the reliability or detracts from the performance, nor does it cover any product which is used commercially. Dry cell batteries are also excluded from coverage under this warranty.

This warranty is extended to the original end user purchaser only. A purchase receipt or other proof of date of original purchase is required before warranty service is performed.

**THIS EXPRESS, LIMITED WARRANTY IS IN LIEU OF ALL OTHER WARRANTIES, EXPRESS OR IMPLIED, INCLUDING ANY IMPLIED WARRANTIES OF MERCHANTABILITY AND FITNESS FOR A PARTICULAR PURPOSE.**

**IN NO EVENT WILL PANASONIC CANADA INC. BE LIABLE FOR ANY SPECIAL, INDIRECT OR CONSEQUENTIAL DAMAGES.**

In certain instances, some jurisdictions do not allow the exclusion or limitation of incidental or consequential damages, or the exclusion of implied warranties, so the above limitations and exclusions may not be applicable.

### **WARRANTY SERVICE**

**FOR PRODUCT OPERATION ASSISTANCE**, please contact:

Our Customer Care Centre: Telephone #:	(905) 624-5505
1-800 #:	1-800-561-5505
Fax #:	(905) 238-2360
Email link:	"Contact Us" on <a href="http://www.panasonic.ca">www.panasonic.ca</a>

**FOR PRODUCT REPAIRS**, please locate your nearest Authorized Servicentre at [www.panasonic.ca](http://www.panasonic.ca) :

Link : "Servicentres™ locator" under "Customer support"

Panasonic Factory Service:

<u>Richmond British Columbia</u>	<u>Mississauga Ontario</u>
Panasonic Canada Inc.	Panasonic Canada Inc.
12111 Riverside Way	5770 Ambler Drive
Richmond BC V6W 1K8	Mississauga ON L4W 2T3
Tel: (604) 278-4211	Tel: (905) 624-8447
Fax: (604) 278-5627	Fax: (905) 238-2418

### **IF YOU SHIP THE PRODUCT TO A SERVICENTRE**

Carefully pack and send prepaid, adequately insured and preferably in the original carton.  
Include details of the defect claimed, and proof of date of original purchase.

# Memo

<b>Angle</b> .....	36	<b>Favorite</b> .....	28	<b>Quick View</b> .....	31
<b>Audio</b>		<b>Finalize</b> .....	52, 68	<b>Quick Start</b> .....	12
Attribute .....	36	<b>Flexible Recording</b> .....	22	<b>Ratings level</b> .....	55
Language .....	55	<b>Format</b> .....	51, 68	<b>Recording</b>	
Playback .....	32	<b>FR (Flexible Recording Mode)</b> .....	21	DV automatic recording .....	47
Receiving, recording .....	22	<b>FUNCTIONS window</b> .....	37	Flexible Recording .....	22
<b>Change Thumbnail</b> .....	39	<b>JPEG</b> .....	34, 68	Mode .....	21
<b>Channel</b>		<b>Language</b>		Relief .....	27
Adjusting, hiding .....	29	Audio .....	55	Scheduled .....	24–27
Audio .....	36	Code list .....	69	<b>Rec. for High-Speed Dubbing</b> .....	55
Auto Channel Setting .....	57	On-screen .....	56	<b>Relief Recording</b> .....	27
Captions .....	58	Soundtrack .....	36, 55	<b>Remote control code</b> .....	19
CHANNEL EDITOR .....	29	Subtitle .....	36, 55	<b>Repeat play</b> .....	36
<b>Chapter</b> .....	32, 38	<b>LPCM</b> .....	56, 68	<b>Restore Default Settings</b> .....	54
<b>Chasing playback</b> .....	23	<b>Menu</b>		<b>Resume play function</b> .....	31
<b>Cleaning</b>		MP3 .....	33	<b>Scheduled recording</b> .....	24–27
Disc .....	5	On-screen .....	36	<b>SD card</b> .....	5, 9
Lens .....	5	SETUP .....	54	<b>SETUP menu</b> .....	54
Main unit .....	5	<b>Mode</b>		<b>Shorten Titles</b> .....	39
<b>Clock setting</b> .....	17, 57	Recording .....	21	<b>Signal Source (RF IN)</b> .....	54
<b>CM Skip</b> .....	32	Still Mode .....	55	<b>Simultaneous rec and play</b> .....	23
<b>Connection</b>		<b>MPEG-DNR</b> .....	37	<b>Soundtrack</b> .....	36
Amplifier, system component .....	15	<b>MP3</b> .....	33	<b>Status messages</b> .....	37
Antenna .....	12, 13, 15	<b>Name</b>		Still pictures	
Cable TV box .....	13	Disc .....	50	Edit .....	42
DV input terminal .....	47	Entering text .....	53	Play .....	34
IN2 input terminals .....	47	Folder .....	42	Transferring (dubbing) .....	48
IR Blaster .....	13	Playlist .....	41	<b>Subtitle</b> .....	36
Television .....	12, 13, 14	Title .....	39	<b>TIFF</b> .....	35, 69
Video cassette recorder .....	12, 13, 14, 47	<b>Noise reduction (NR)</b>		<b>Time Slip</b> .....	23, 32
<b>Copy (playlist)</b> .....	41	Integrated DNR .....	37	<b>Transfer</b> .....	37
<b>CPRM</b> .....	68	MPEG-DNR .....	37	<b>Transfer (dubbing)</b>	
<b>Create Chapter</b> .....	32, 39	Line-in NR .....	37	Still picture .....	48
<b>Create playlists</b> .....	40	<b>One Touch Transfer (dubbing)</b> .....	44	Title/play list .....	43
<b>Dialog Enhancer</b> .....	37	<b>On-screen</b>		<b>TV Guide On Screen™</b> .....	16, 24, 28
<b>Direct Navigator</b> .....	30, 34, 38, 42	Language .....	56	<b>TV Type</b> .....	18
<b>Divide Title</b> .....	39	Menus .....	36	<b>VCR Plus+</b> .....	26
<b>DPOF</b> .....	42, 68	Status messages .....	37	<b>V.S.S.</b> .....	37
<b>DV automatic recording</b> .....	47	<b>PCM Down Conversion</b> .....	56		
<b>DVD-RAM, DVD-R, DVD-RW, +R</b> .....	8–9	<b>Picture</b> .....	34		
<b>Enabling discs to be played on other equipment—Finalize</b> .....	52	<b>Playlist</b> .....	40		
<b>Erase</b>		<b>Progressive</b> .....	37, 68		
All titles .....	51	<b>Properties</b>			
Chapter .....	32, 39, 41	Playlist .....	41		
Folder .....	42	Still picture .....	34		
Playlist .....	32, 41	Title .....	39		
Still picture .....	42	<b>Protection</b>			
Title .....	32, 39	Card .....	50		
		Cartridge .....	50		
		Disc .....	50		
		Folder .....	42		
		Still picture .....	42		
		Title .....	39		

Manufactured under license from Dolby Laboratories. "Dolby" and the double-D symbol are trademarks of Dolby Laboratories.

"DTS" and "DTS 2.0 + Digital Out" are trademarks of Digital Theater Systems, Inc.

U.S. patent Nos. 4,631,603, 4,577,216, 4,819,098, and 4,907,093.

MPEG Layer-3 audio decoding technology licensed from Fraunhofer IIS and Thomson multimedia.

●SD logo is a trademark.

●Portions of this product are protected under copyright law and are provided under license by ARIS/SOLANA/4C.

This product incorporates copyright protection technology that is protected by U.S. patents and other intellectual property rights. Use of this copyright protection technology must be authorized by Macrovision, and is intended for home and other limited consumer uses only unless otherwise authorized by Macrovision. Reverse engineering or disassembly is prohibited.